



IP68 Oscar 40 Pro

5G/LTE Wideband IP68 Outdoor Antenna for 600-8000 MHz

Key Features

- IP68-rated: dust-tight and protected against prolonged water immersion
- Supports 5G NR, 4G LTE, 3G UMTS, 2G GSM
- Covers LTE Cat M, NB-IoT, and LoRa bands
- Wide frequency range (600-8000 MHz) with high efficiency (~80-90% avg)
- Omni-directional with high peak gains of 3-5 dBi
- Suitable for pole or wall mounting, with optional colour finishes (white/black)
- Available with brass SMA Male connector with ternary alloy plating for resistance to salt spray environments

Typical Applications

- Fixed Wireless Access (FWA) for 4G/5G rural and remote internet
- IoT and LPWAN for asset tracking, agriculture, and monitoring
- Industrial automation and M2M in manufacturing, logistics and utilities
- Smart city infrastructure, lighting, and waste management
- Building and perimeter security for LTE/5G-connected cameras

General Description

The IP68 Oscar 40 Pro antenna is a versatile outdoor solution for 5G and LTE applications across a broad frequency range from 600 MHz to 8000 MHz. With an IP68 rating, it is built to withstand harsh environments, making it suitable for both indoor and outdoor installations.

The omni-directional radiation pattern and peak gain of up to 5 dBi deliver reliable coverage for cellular, IoT, and other wireless communications. Flexible mounting options allow for pole or wall installation. For pole mounting, the antenna is supplied with two adjustable stainless steel worm-drive clamps, fitting poles up to 65 mm in diameter.

The IP68 Oscar 40 Pro is available in white or black finishes and is terminated with a corrosion-resistant SMA Male connector with ternary alloy plating for enhanced durability in outdoor environments.

O Wall/Pole	5G New Radio	4G LTE	3G UMTS	2G GSM	LTE M
LTE NB-IoT	NR NB-IoT	LoRa Wireless	SF Sigfox	W Weightless	HNT Helium
ISM 2.4G	ISM 5.8G	IEEE 802.15.4	WiFi 2.4G & 5G	WiFi 6 802.11ax	WiFi 6e 802.11ax
WiFi 7 802.11be	WLAN 2400	WLAN 5800	BLE Bluetooth	Z Wave	



IP68 Oscar 40 Pro

5G/LTE Wideband IP68 Outdoor Antenna for 600-8000 MHz

Electrical Specifications

Frequency range:	600 - 8000 MHz
Impedance:	50 Ω
Polarisation:	Vertical
Average gain:	2-5 dBi
Peak gain:	6.73 dBi
Efficiency:	80-90%
VSWR:	<2.5%
Max input power:	50 W
Number of ports:	1
Directionality:	Omni-directional
Ground plane independent:	Yes

Environmental Specifications

IP Rating:	IP68 (excluding connector)
Operating temperature range:	-45 °C to +75 °C
Storage temperature range:	-50 °C to +75 °C

Mechanical Specifications

Dimensions:	Ø 83 mm x 196.5 mm
Weight:	0.8 kg
Connector:	SMA Male
Connector Materials:	Brass with turnary alloy plating
Mounting method:	Pole (up to Ø65 mm) or wall mount
Cable length:	10 M
Hosuing materials:	ASA UV-stabilised
Colour Options:	White/Black

IP68 Oscar 40 Pro

5G/LTE Wideband IP68 Outdoor Antenna for 600-8000 MHz

Dimensional Drawing (with cable)

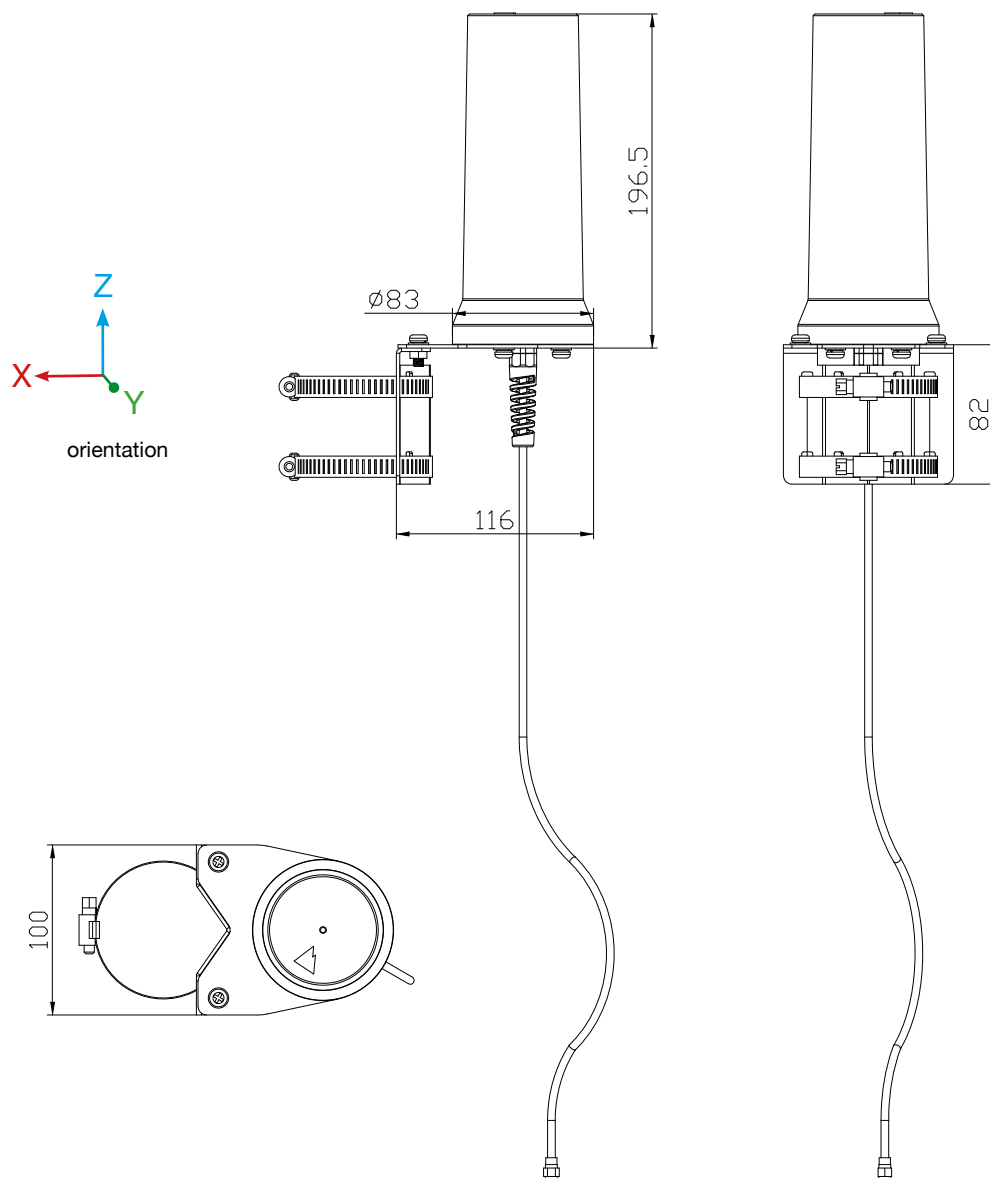



IP68 Oscar 40 Pro

5G/LTE Wideband IP68 Outdoor Antenna for 600-8000 MHz

Spectrum Coverage

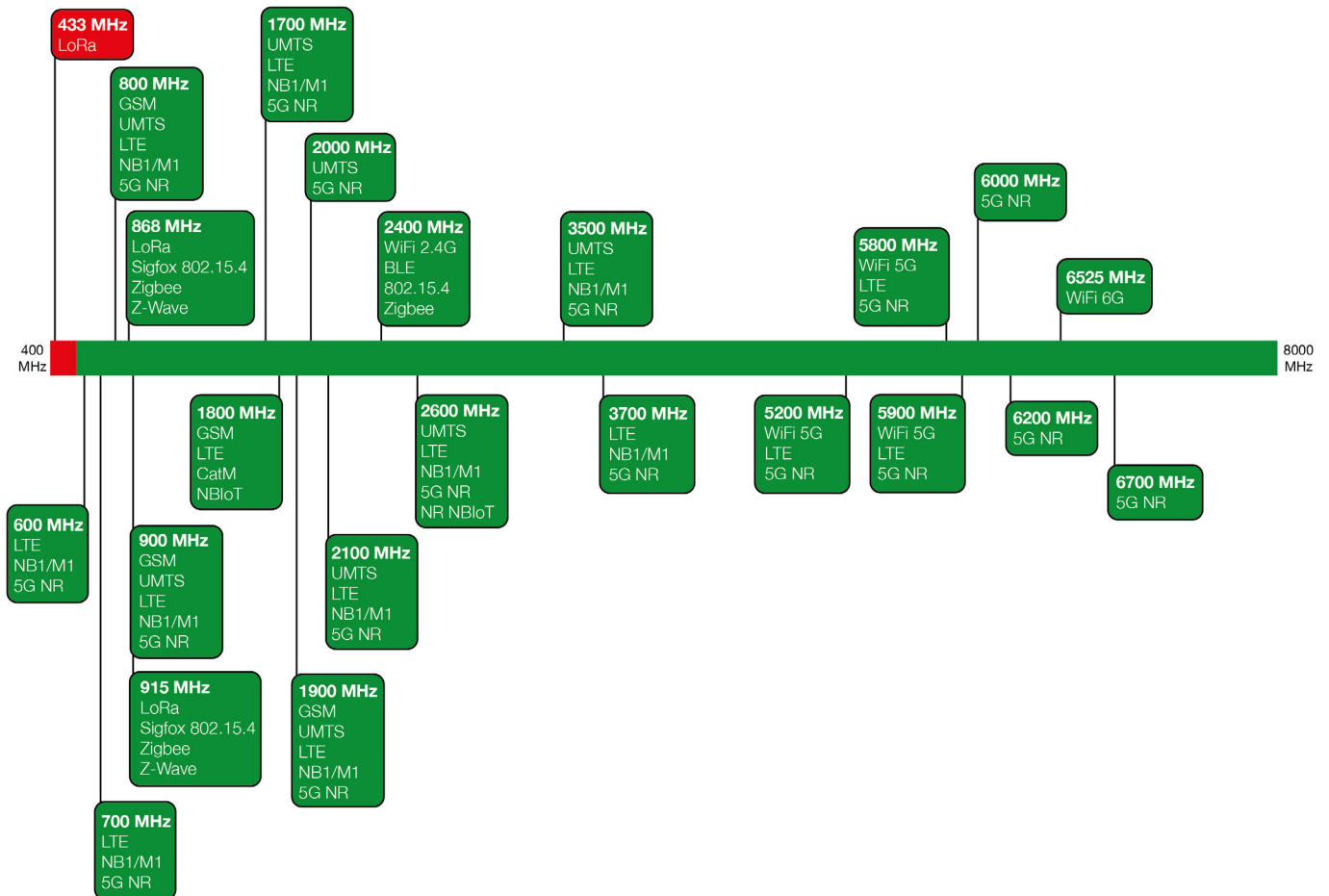

● Suitable band

● Adequate band in good signal conditions

● Likely to be unsuitable



IP68 Oscar 40 Pro

5G/LTE Wideband IP68 Outdoor Antenna for 600-8000 MHz

Peak Gain vs. Frequency

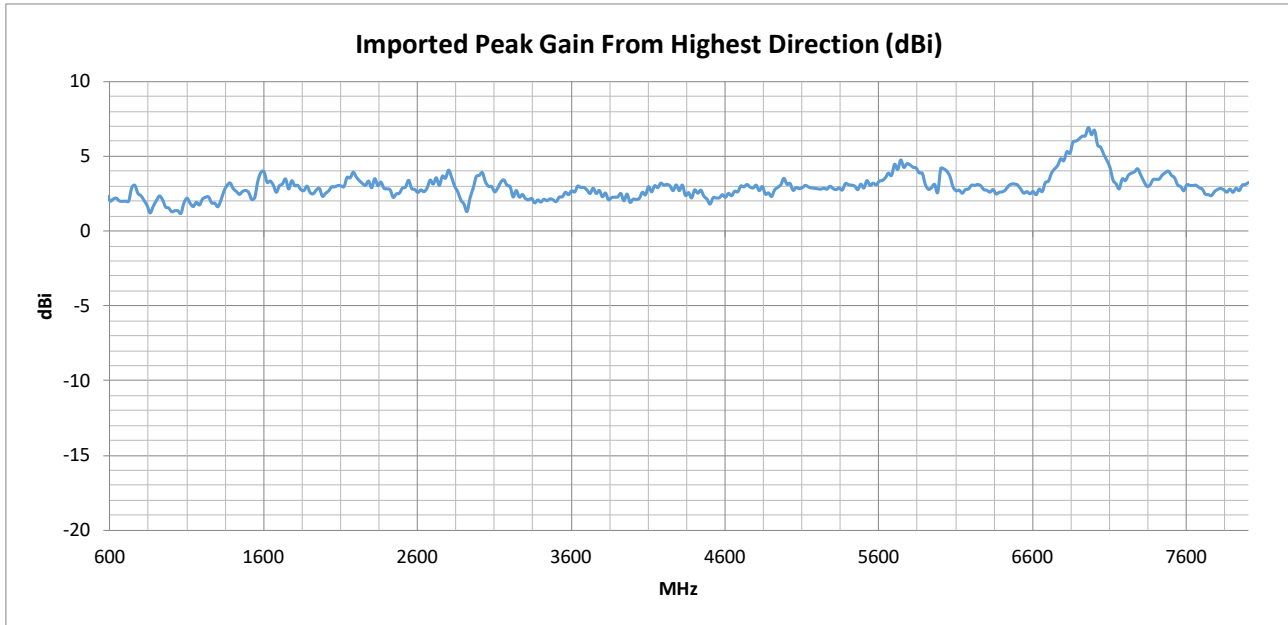

VSWR

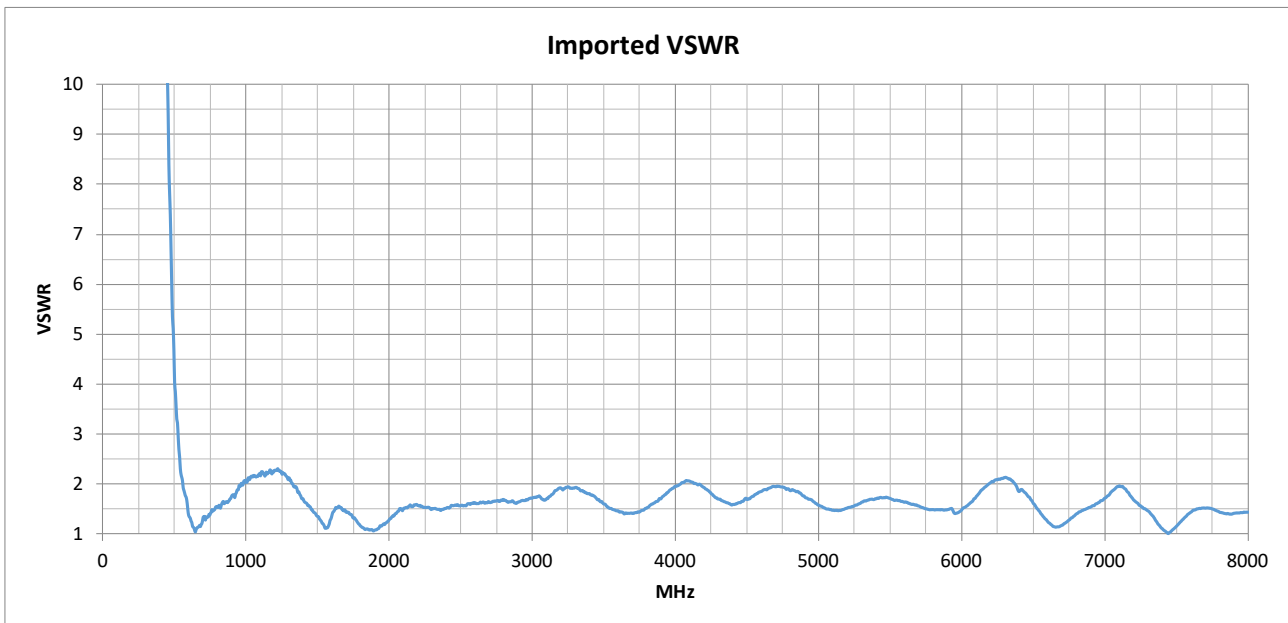



IP68 Oscar 40 Pro

5G/LTE Wideband IP68 Outdoor Antenna for 600-8000 MHz

Radiation Efficiency

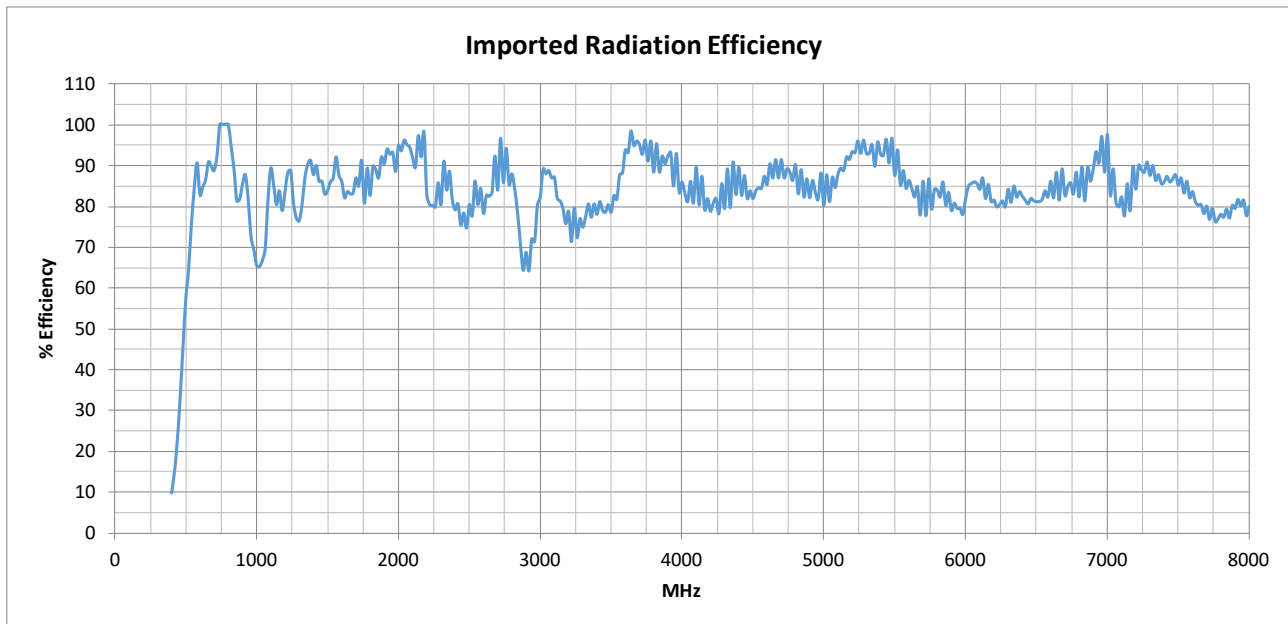



IP68 Oscar 40 Pro

5G/LTE Wideband IP68 Outdoor Antenna for 600-8000 MHz

Usable Cellular Frequency Support (400 MHz – 2000 MHz)

	400	410	450	600	700	800	850	900	1500	1600	1700	1800	1900	2000
GSM Bands:							●	●				●	●	
UMTS Bands:					●	●	●	●	●		●	●	●	
LTE Bands:				●	●	●	●	●	●	●	●	●	●	
LTE Cat M Bands:				●	●	●	●	●	●	●	●	●	●	●
LTE Cat NB Bands:				●	●	●	●	●	●	●	●	●	●	
5G NR Bands:				●	●	●	●	●	●	●	●	●	●	●
NR Cat NB Bands:				●	●	●	●	●	●	●		●	●	●
NTN Bands:										●				●

Usable Cellular Frequency Support (2100 MHz – 6700 MHz)

	2100	2300	2400	2500	2600	3300	3500	3700	4700	5200	5900	6000	6200	6700
GSM Bands:														
UMTS Bands:	●				●		●							
LTE Bands:	●	●	●	●	●	●	●	●		●	●			
LTE Cat M Bands:	●	●		●	●		●	●						
LTE Cat NB Bands:	●			●	●		●	●						
5G NR Bands:	●	●	●	●	●		●	●	●	●	●	●	●	●
NR Cat NB Bands:	●			●	●									
NTN Bands:	●			●	●									



IP68 Oscar 40 Pro

5G/LTE Wideband IP68 Outdoor Antenna for 600-8000 MHz

Usable ISM Frequency Support (433 MHz - 6525 MHz)

	433	868	915	2450	5800	6525
Bluetooth				●		
Helium		●	●			
IEEE 802.15.4		●	●	●		
ISM 433						
ISM 868		●				
ISM 915			●			
ISM 2.4G				●		
ISM 5.8G					●	
LoRa		●	●			
SigFox		●	●			
Weightless		●	●			
Wi-Fi 2.4G						
Wi-Fi 5G						
Wi-Fi 6E					●	
Zigbee		●	●	●		●
Z-Wave		●	●			



IP68 Oscar 40 Pro

5G/LTE Wideband IP68 Outdoor Antenna for 600-8000 MHz

Cellular Standards Band Support

GSM (2G) Band	UMTS (3G) Band	E-UTRA (4G) Band	Cat M E-UTRA Band	Cat NB E-UTRA Band	NR (5G) Band	Cat NB NR (5G) Band	NTN Band	Uplink	Downlink	Average Upload Efficiency (%)	Average Download Efficiency (%)	Maximum Upload VSWR	Maximum Download VSWR	Use Indicator
	1	1	1	1	n1	n1		1920 - 1980 MHz	2110 - 2170 MHz	92.34	93.30	1.22	1.58	●
PCS-1900	2	2	2	2	n2	n2		1850 - 1910 MHz	1930 - 1990 MHz	90.00	91.75	1.10	1.24	●
DCS-1800	3	3	3	3	n3	n3		1710 - 1785 MHz	1805 - 1880 MHz	86.37	88.54	1.44	1.15	●
	4	4	4	4				1710 - 1755 MHz	2110 - 2155 MHz	87.20	93.31	1.44	1.58	●
GSM-850	5	5	5	5	n5	n5		824 - 849 MHz	869 - 894 MHz	89.90	82.33	1.65	1.70	●
	6							830 - 840 MHz	875 - 885 MHz	90.50	81.87	1.63	1.66	●
	7	7	7	7	n7	n7		2500 - 2570 MHz	2620 - 2690 MHz	81.36	85.23	1.60	1.64	●
E-GSM-900	8	8	8	8	n8	n8		880 - 915 MHz	925 - 960 MHz	84.65	80.15	1.78	1.97	●
	9	9						1749.9 - 1784.9 MHz	1844.9 - 1879.9 MHz	85.04	88.69	1.32	1.10	●
	10	10						1710 - 1770 MHz	2110 - 2170 MHz	86.05	93.30	1.44	1.58	●
	11	11	11	11				1427.9 - 1447.9 MHz	1475.9 - 1495.9 MHz	86.81	83.29	1.60	1.43	●
	12	12	12	12	n12	n12		699 - 716 MHz	729 - 746 MHz	90.05	98.62	1.35	1.39	●
	13	13	13	13	n13			777 - 787 MHz	746 - 756 MHz	100.00	100.00	1.50	1.41	●
	14	14	14	14	n14	n14		788 - 798 MHz	758 - 768 MHz	100.00	100.00	1.54	1.48	●
		17		17				704 - 716 MHz	734 - 746 MHz	90.49	99.41	1.35	1.39	●
		18	18	18	n18	n18		815 - 830 MHz	860 - 875 MHz	93.93	81.42	1.57	1.64	●
	19	19	19	19				830 - 845 MHz	875 - 890 MHz	89.71	82.25	1.65	1.69	●
	20	20	20	20	n20	n20		832 - 862 MHz	791 - 821 MHz	86.28	98.02	1.65	1.57	●
	21	21	21	21				1447.9 - 1462.9 MHz	1495.9 - 1510.9 MHz	86.05	84.16	1.54	1.36	●
	22	22						3410 - 3490 MHz	3510 - 3590 MHz	79.56	85.07	1.78	1.59	●
		24	24	24	n24	n24		1626.5 - 1660.5 MHz	1525 - 1559 MHz	83.18	88.10	1.55	1.26	●
	25	25	25	25	n25	n25		1850 - 1915 MHz	1930 - 1995 MHz	90.20	91.81	1.10	1.25	●
	26	26	26	26	n26	n26		814 - 849 MHz	859 - 894 MHz	91.32	82.06	1.65	1.70	●
		27	27					807 - 824 MHz	852 - 869 MHz	95.83	82.07	1.57	1.64	●
		28	28	28	n28	n28		703 - 748 MHz	758 - 803 MHz	94.79	99.97	1.39	1.54	●

● Suitable band

● Adequate band in good signal conditions

● Likely to be unsuitable



IP68 Oscar 40 Pro

5G/LTE Wideband IP68 Outdoor Antenna for 600-8000 MHz

Cellular Standards Band Support

GSM (2G) Band	UMTS (3G) Band	E-UTRA (4G) Band	Cat M E-UTRA Band	Cat NB E-UTRA Band	NR (5G) Band	Cat NB NR (5G) Band	NTN Band	Uplink	Downlink	Average Upload Efficiency (%)	Average Download Efficiency (%)	Maximum Upload VSWR	Maximum Download VSWR	Use Indicator
		28A						703 - 733 MHz	758 - 788 MHz	92.50	100.00	1.35	1.51	●
		29			n29			N/A	717 - 728 MHz	N/A	93.31	N/A	1.33	●
		30			n30			2305 - 2315 MHz	2350 - 2360 MHz	85.67	87.37	1.51	1.49	●
		31	31	31				452.5 - 457.5 MHz	462.5 - 467.5 MHz	30.26	35.96	10.56	8.90	●
	32	32						N/A	1452 - 1496 MHz	N/A	84.37	N/A	1.53	●
		33						1900 - 1920 MHz	1900 - 1920 MHz	92.17	92.17	1.09	1.09	●
		34			n34			2010 - 2025 MHz	2010 - 2025 MHz	93.87	93.87	1.35	1.35	●
		35						1850 - 1910 MHz	1850 - 1910 MHz	90.00	90.00	1.10	1.10	●
		36						1930 - 1990 MHz	1930 - 1990 MHz	91.75	91.75	1.24	1.24	●
		37						1910 - 1930 MHz	1910 - 1930 MHz	93.36	93.36	1.11	1.11	●
		38			n38			2570 - 2620 MHz	2570 - 2620 MHz	81.32	81.32	1.62	1.62	●
		39	39		n39			1880 - 1920 MHz	1880 - 1920 MHz	91.69	91.69	1.09	1.09	●
		40	40		n40			2300 - 2400 MHz	2300 - 2400 MHz	84.92	84.92	1.51	1.51	●
		41	41	41	n41	n41		2496 - 2690 MHz	2496 - 2690 MHz	82.71	82.71	1.64	1.64	●
		42	42	42				3400 - 3600 MHz	3400 - 3600 MHz	82.33	82.33	1.81	1.81	●
		43	43	43				3600 - 3800 MHz	3600 - 3800 MHz	94.41	94.41	1.51	1.51	●
		44						703 - 803 MHz	703 - 803 MHz	97.64	97.64	1.54	1.54	●
		45						1447 - 1467 MHz	1447 - 1467 MHz	85.91	85.91	1.55	1.55	●
		46			n46			5150 - 5925 MHz	5150 - 5925 MHz	88.08	88.08	1.73	1.73	●
		47			n47			5855 - 5925 MHz	5855 - 5925 MHz	80.87	80.87	1.51	1.51	●
		48	48	48	n48			3550 - 3700 MHz	3550 - 3700 MHz	93.15	93.15	1.51	1.51	●
		49						3550 - 3700 MHz	3550 - 3700 MHz	93.15	93.15	1.51	1.51	●
		50			n50			1432 - 1517 MHz	1432 - 1517 MHz	84.88	84.88	1.58	1.58	●
		51			n51			1427 - 1432 MHz	1427 - 1432 MHz	88.12	88.12	1.61	1.61	●
		52						3300 - 3400 MHz	3300 - 3400 MHz	78.44	78.44	1.93	1.93	●

● Suitable band

● Adequate band in good signal conditions

● Likely to be unsuitable



IP68 Oscar 40 Pro

5G/LTE Wideband IP68 Outdoor Antenna for 600-8000 MHz

Cellular Standards Band Support

GSM (2G) Band	UMTS (3G) Band	E-UTRA (4G) Band	Cat M E-UTRA Band	Cat NB E-UTRA Band	NR (5G) Band	Cat NB NR (5G) Band	NTN Band	Uplink	Downlink	Average Upload Efficiency (%)	Average Download Efficiency (%)	Maximum Upload VSWR	Maximum Downward VSWR	Use Indicator
		53			n53			2483.5 - 2495 MHz	2483.5 - 2495 MHz	77.28	77.28	1.57	1.57	●
								1670 - 1675 MHz	1670 - 1675 MHz	83.10	83.10	1.52	1.52	●
		65		65	n65	n65		1920 - 2010 MHz	2110 - 2200 MHz	92.44	93.04	1.30	1.59	●
		66	66	66	n66	n66		1710 - 1780 MHz	2110 - 2200 MHz	86.22	93.04	1.44	1.59	●
		67			n67			N/A	738 - 758 MHz	N/A	99.96	N/A	1.42	●
		68						698 - 728 MHz	753 - 783 MHz	91.26	100.00	1.35	1.48	●
		69						N/A	2570 - 2620 MHz	N/A	81.32	N/A	1.62	●
		70		70	n70	n70		1695 - 1710 MHz	1995 - 2020 MHz	86.41	94.16	1.47	1.34	●
		71	71	71	n71	n71		663 - 698 MHz	617 - 652 MHz	89.72	86.27	1.24	1.29	●
		72	72	72				451 - 456 MHz	461 - 466 MHz	29.47	35.04	10.82	9.20	●
		73	73	73				450 - 455 MHz	460 - 465 MHz	28.95	34.42	10.98	9.41	●
		74	74	74	n74	n74		1427 - 1470 MHz	1475 - 1518 MHz	86.30	83.94	1.61	1.43	●
		75			n75			N/A	1432 - 1517 MHz	N/A	84.88	N/A	1.58	●
		76			n76			N/A	1427 - 1432 MHz	N/A	88.12	N/A	1.61	●
					n77			3300 - 4200 MHz	3300 - 4200 MHz	86.47	86.47	2.07	2.07	●
					n78			3300 - 3800 MHz	3300 - 3800 MHz	86.39	86.39	1.93	1.93	●
					n79			4400 - 5000 MHz	4400 - 5000 MHz	85.92	85.92	1.95	1.95	●
					n80			1710 - 1785 MHz	N/A	86.37	N/A	1.44	N/A	●
					n81			880 - 915 MHz	N/A	84.65	N/A	1.78	N/A	●
					n82			832 - 862 MHz	N/A	86.28	N/A	1.65	N/A	●
					n83			703 - 748 MHz	N/A	94.79	N/A	1.39	N/A	●
					n84			1920 - 1980 MHz	N/A	92.34	N/A	1.22	N/A	●
		85	85	85	n85			698 - 716 MHz	728 - 746 MHz	89.98	98.45	1.35	1.39	●
					n86			1710 - 1780 MHz	N/A	86.22	N/A	1.44	N/A	●
		87	87	87				410 - 415 MHz	420 - 425 MHz	12.90	15.74	21.00	17.21	●

● Suitable band

● Adequate band in good signal conditions

● Likely to be unsuitable



IP68 Oscar 40 Pro

5G/LTE Wideband IP68 Outdoor Antenna for 600-8000 MHz

Cellular Standards Band Support

GSM (2G) Band	UMTS (3G) Band	E-UTRA (4G) Band	Cat M E-UTRA Band	Cat NB E-UTRA Band	NR (5G) Band	Cat NB NR (5G) Band	NTN Band	Uplink	Downlink	Average Upload Efficiency (%)	Average Download Efficiency (%)	Maximum Upload VSWR	Maximum Download VSWR	Use Indicator
		88	88	88				412 - 417 MHz	422 - 427 MHz	13.40	16.50	20.06	16.56	●
					n89			824 - 849 MHz	N/A	89.90	N/A	1.65	N/A	●
					n90	n90		2496 - 2690 MHz	2496 - 2690 MHz	82.71	82.71	1.64	1.64	●
					n91			832 - 862 MHz	1427 - 1432 MHz	86.28	88.12	1.65	1.61	●
					n92			832 - 862 MHz	1432 - 1517 MHz	86.28	84.88	1.65	1.58	●
					n93			880 - 915 MHz	1427 - 1432 MHz	84.65	88.12	1.78	1.61	●
					n94			880 - 915 MHz	1432 - 1517 MHz	84.65	84.88	1.78	1.58	●
					n95			2010 - 2025 MHz	N/A	93.87	N/A	1.35	N/A	●
					n96			5925 - 7125 MHz	5925 - 7125 MHz	84.44	84.44	2.13	2.13	●
					n97			2300 - 2400 MHz	N/A	84.92	N/A	1.51	N/A	●
					n98			1880 - 1920 MHz	N/A	91.69	N/A	1.09	N/A	●
					n99			1626.5 - 1660.5 MHz	N/A	83.18	N/A	1.55	N/A	●
1900					n101			1900 - 1910 MHz	1900 - 1910 MHz	91.27	91.27	1.08	1.08	●
					n102			5925 - 6425 MHz	5925 - 6425 MHz	83.33	83.33	2.13	2.13	●
				103				787 - 788 MHz	757 - 758 MHz	100.00	100.00	1.51	1.42	●
					n104			6425 - 7125 MHz	6425 - 7125 MHz	85.23	85.23	1.96	1.96	●
								663 - 703 MHz	612 - 652 MHz	89.62	86.01	1.31	1.32	●
							n254	1610 - 1625.5 MHz	2483.5 - 2500 MHz	82.77	78.00	1.50	1.57	●
							n255	1626.5 - 1660.5 MHz	1525 - 1559 MHz	83.18	88.10	1.55	1.26	●
							n256	1980 - 2010 MHz	2170 - 2200 MHz	92.62	92.53	1.30	1.59	●

● Suitable band ● Adequate band in good signal conditions ● Likely to be unsuitable

NOTE: For each frequency band, Siretta provides a traffic light indication to show the suitability of the antenna for use at that frequency band. Determination of exactly what makes an antenna good or bad at any frequency is subjective.

The view presented is that of Siretta's engineering team having taken into account the efficiency and VSWR measurements. The end user is advised to use their own criteria and/or testing to confirm suitability.



IP68 Oscar 40 Pro

5G/LTE Wideband IP68 Outdoor Antenna for 600-8000 MHz

ISM Standards Frequency Support

Application	Frequency Range	Efficiency (%)	Maximum VSWR	Peak Gain from highest direction (dBi)	Use Indicator
ISM 2.4 GHz	2400 - 2500 MHz	84.37	1.58	4.68	●
Wi-Fi 2.4G	2401 - 2483 MHz	84.64	1.56	4.68	●
Wi-Fi 2.4G (USA)	2401 - 2473 MHz	85.14	1.54	4.68	●
Wi-Fi 2.4G (Japan)	2401 - 2495 MHz	84.36	1.58	4.68	●
Wi-Fi 5G (all channels)	5150 - 5990 MHz	90.42	1.68	4.97	●
Wi-Fi 5G (Ch 32-48)	5150 - 5250 MHz	96.43	1.64	3.26	●
Wi-Fi 5G (Ch 32-64)	5150 - 5330 MHz	97.00	1.64	3.26	●
Wi-Fi 5G (Ch 32-161)	5150 - 5815 MHz	91.34	1.68	4.97	●
Wi-Fi 5G (Ch 32-173)	5150 - 5875 MHz	91.12	1.68	4.97	●
Wi-Fi 6E (Ch 1-93)	5925 - 6425 MHz	83.33	2.13	4.59	●
Wi-Fi 6E (all channels)	5925 - 7125 MHz	84.44	2.13	6.92	●
ISM 5.8 GHz	5725 - 5875 MHz	87.64	1.66	4.76	●
UWB band 1	3168 - 3696 MHz	85.75	2.03	3.35	●
UWB band 2	3696 - 4224 MHz	88.70	2.01	3.38	●
UWB band 3	4224 - 4752 MHz	90.48	1.92	3.64	●
UWB band 4	4752 - 5280 MHz	89.79	1.81	3.61	●
UWB band 5	5280 - 5808 MHz	90.02	1.68	4.97	●
UWB band 6	5808 - 6336 MHz	84.41	2.13	4.74	●
UWB band 7	6336 - 6864 MHz	83.70	2.10	5.96	●
UWB band 8	6864 - 7392 MHz	87.24	1.96	6.92	●
UWB band 9	7392 - 7920 MHz	81.55	1.52	4.00	●

● Suitable band

● Adequate band in good signal conditions

● Likely to be unsuitable

NOTE: For each frequency band, Siretta provides a traffic light indication to show the suitability of the antenna for use at that frequency band. Determination of exactly what makes an antenna good or bad at any frequency is subjective.

The view presented is that of Siretta's engineering team having taken into account the efficiency and VSWR measurements. The end user is advised to use their own criteria and/or testing to confirm suitability.



Siretta

Enabling Industrial IoT



IP68 Oscar 40 Pro

5G/LTE Wideband IP68 Outdoor Antenna for 600-8000 MHz

Test Setup (in Free Space)

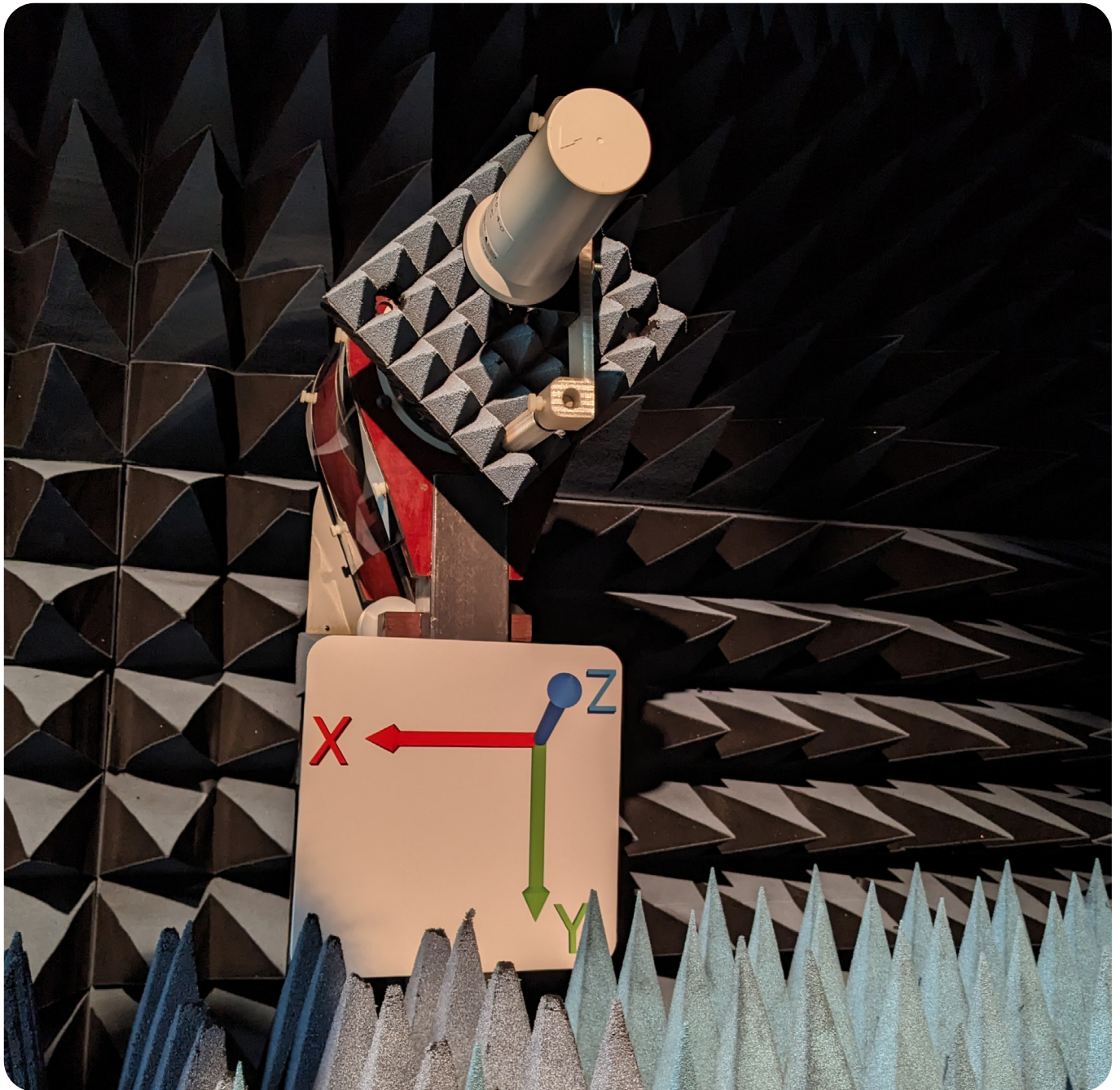

Registered in England No. 08405712
VAT Registration No. GB163 04 0349



Siretta Ltd
Basingstoke Road
Spencers Wood
Reading
Berkshire RG7 1PW

sales
email
web

+44 118 796 9000
sales@siretta.com
www.siretta.com

[Download Latest Edition](#)

Rev 1.0



IP68 Oscar 40 Pro

5G/LTE Wideband IP68 Outdoor Antenna for 600-8000 MHz

2D Radiation Plots

600 MHz XY

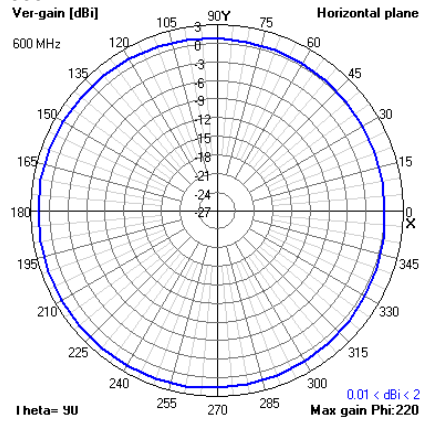

XZ

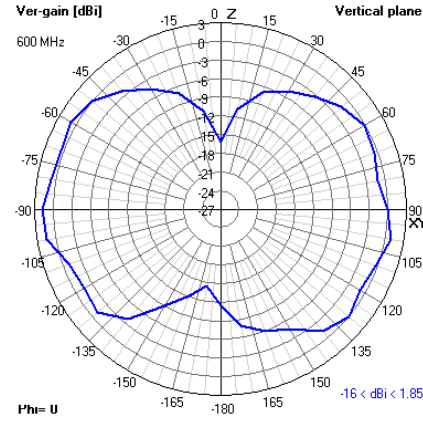

YZ

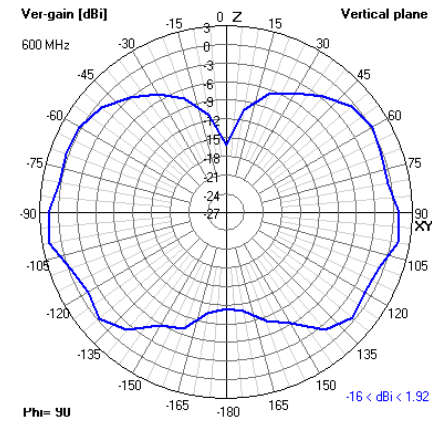

700 MHz XY

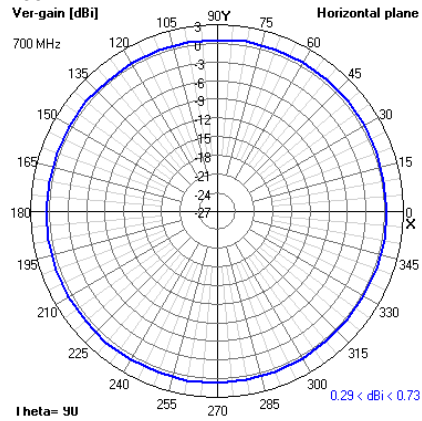

XZ

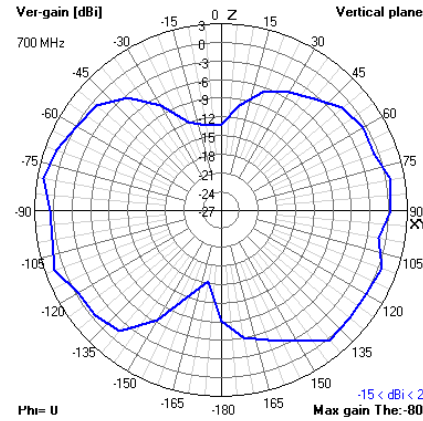

YZ

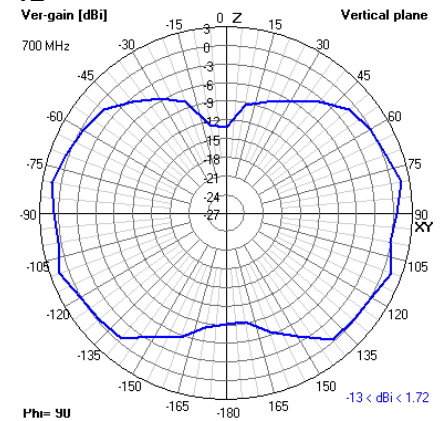

800 MHz XY

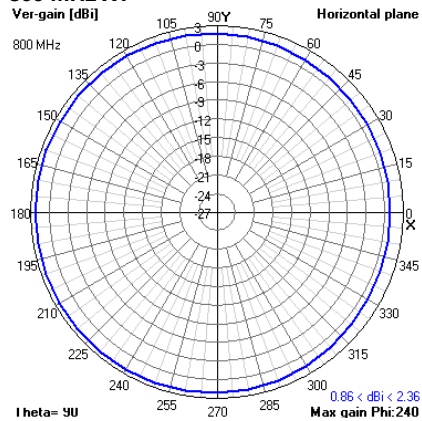

XZ

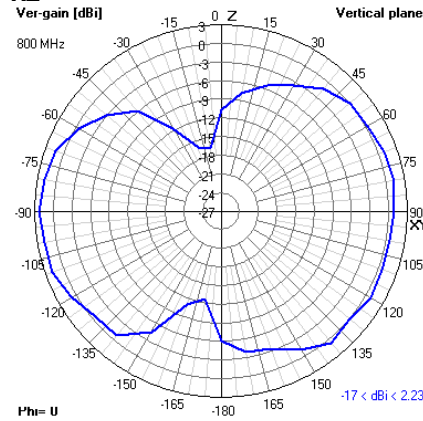

YZ

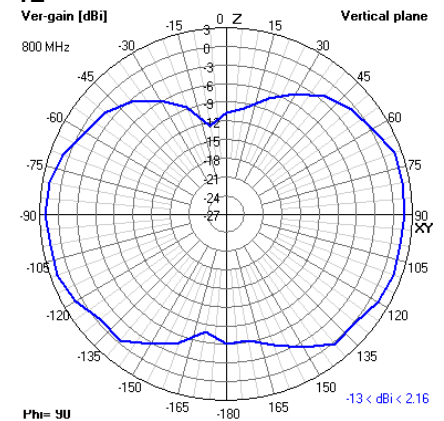



IP68 Oscar 40 Pro

5G/LTE Wideband IP68 Outdoor Antenna for 600-8000 MHz

2D Radiation Plots

860 MHz XY

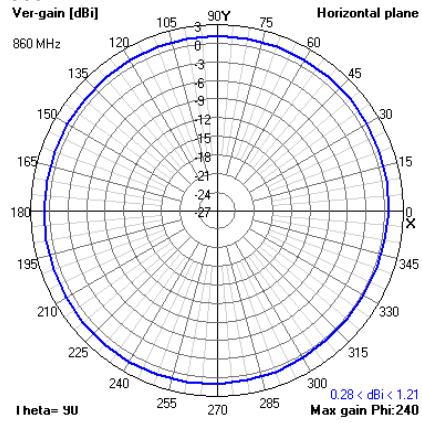

XZ

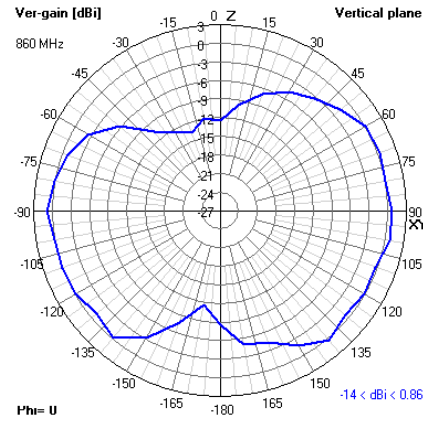

YZ

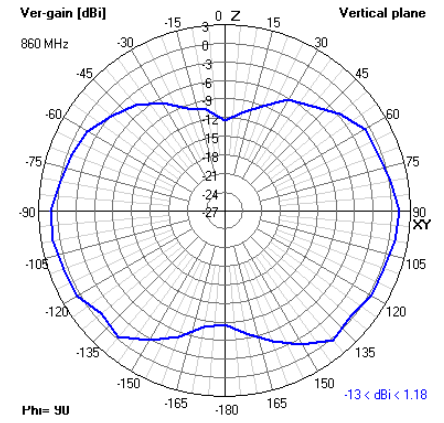

900 MHz XY

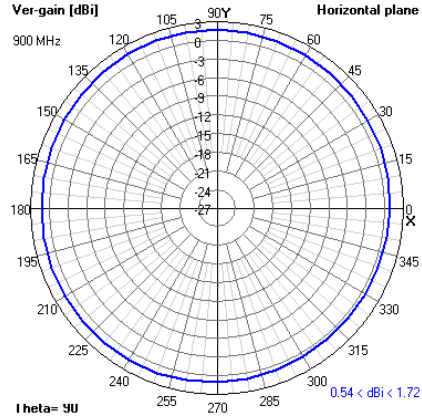

XZ

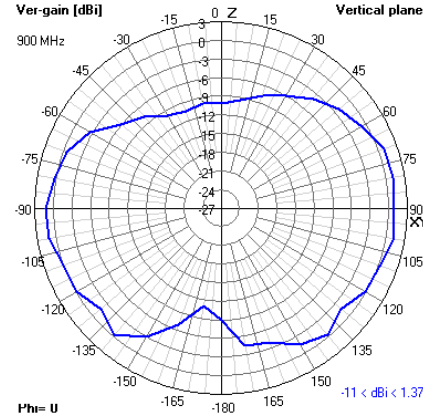

YZ

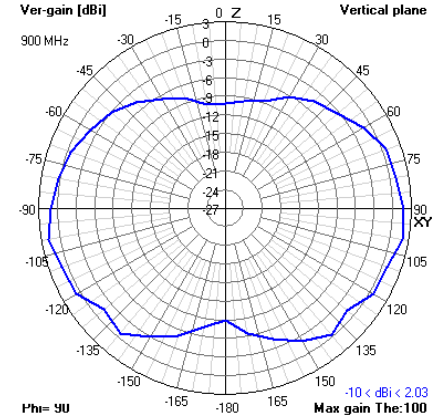

1500 MHz XY

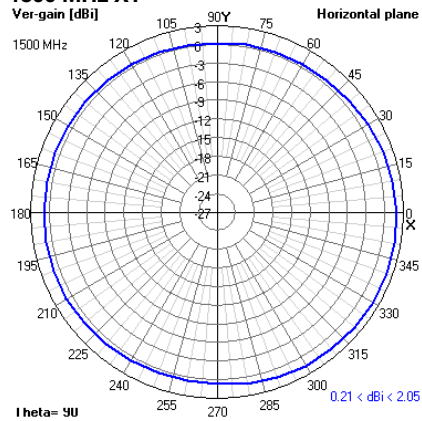

XZ

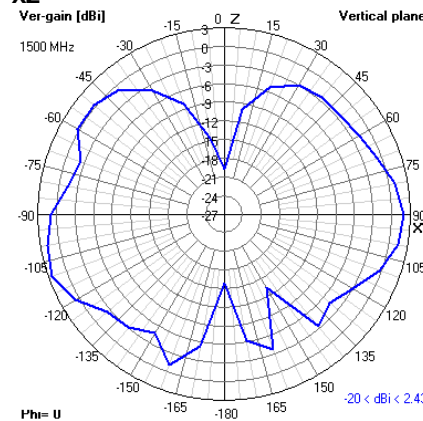

YZ

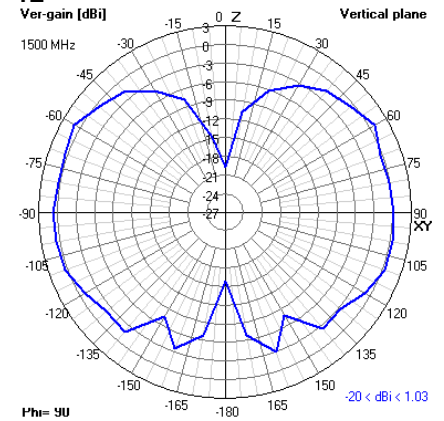



IP68 Oscar 40 Pro

5G/LTE Wideband IP68 Outdoor Antenna for 600-8000 MHz

2D Radiation Plots

1600 MHz XY

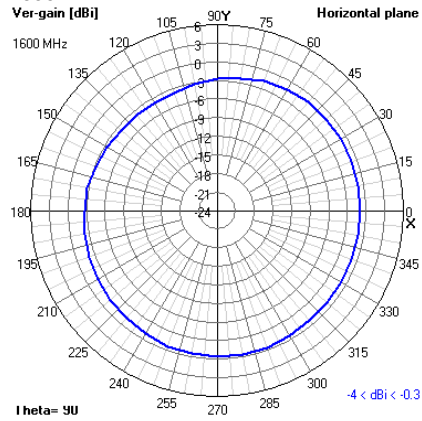

XZ

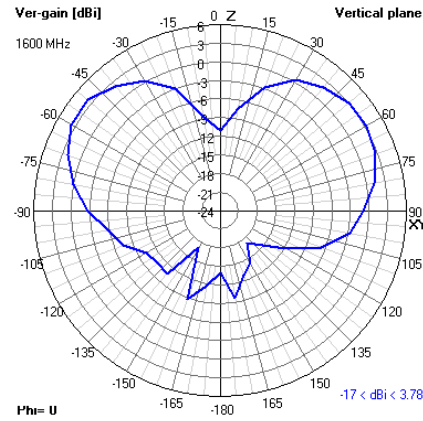

YZ

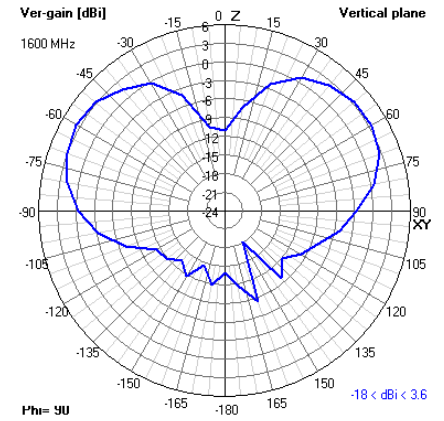

1700 MHz XY

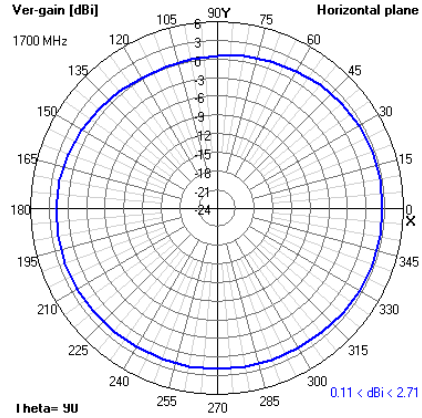

XZ

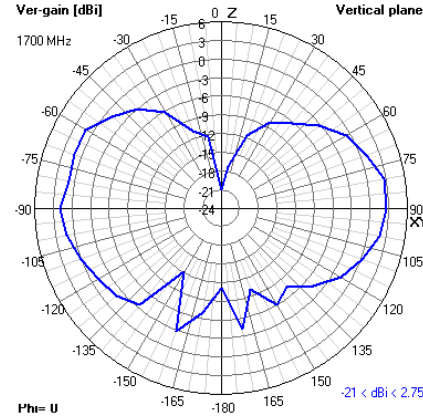

YZ

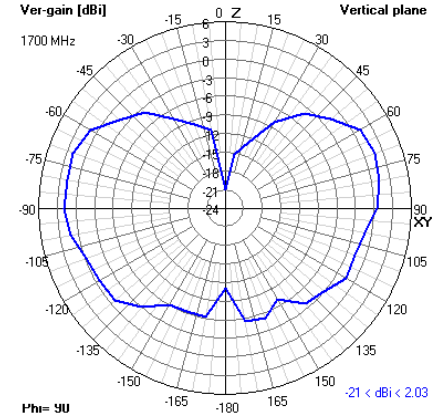

1800 MHz XY

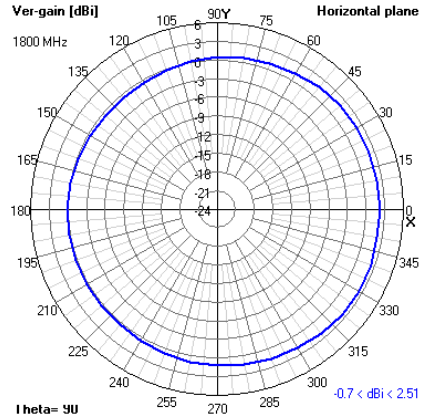

XZ

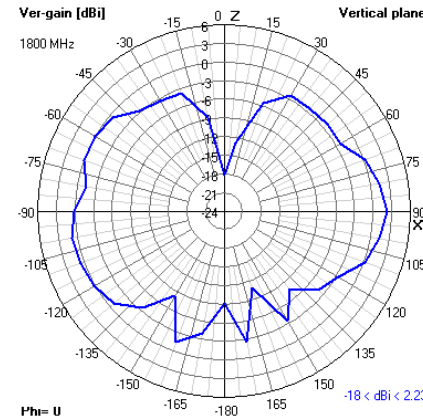

YZ

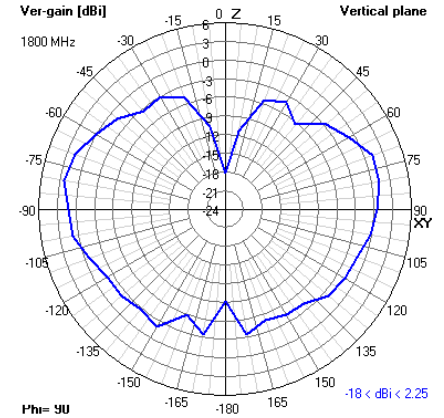



IP68 Oscar 40 Pro

5G/LTE Wideband IP68 Outdoor Antenna for 600-8000 MHz

2D Radiation Plots

1900 MHz XY

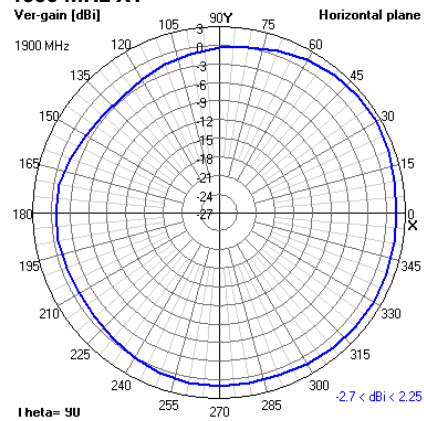

XZ

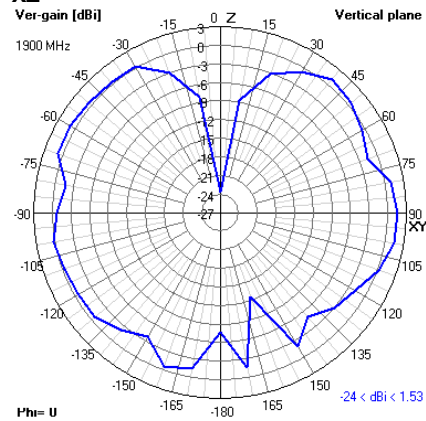

YZ

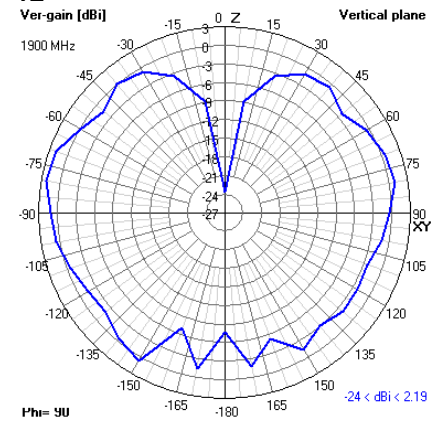

2000 MHz XY

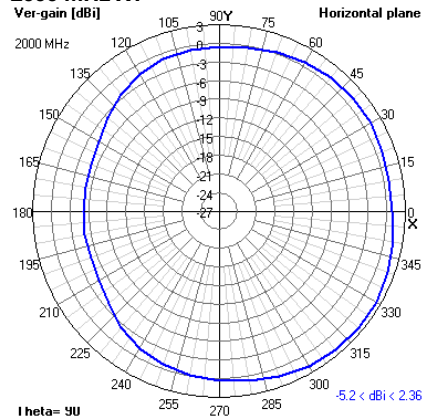

XZ

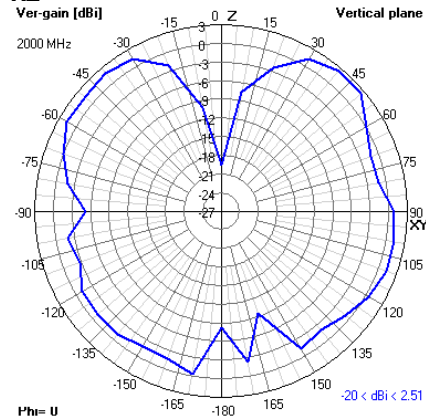

YZ

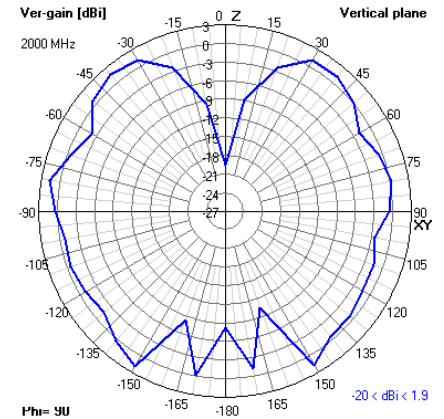

2100 MHz XY

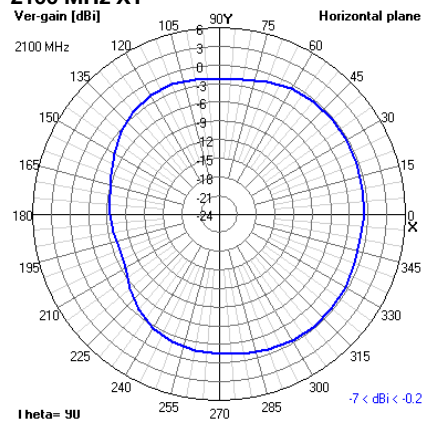

XZ

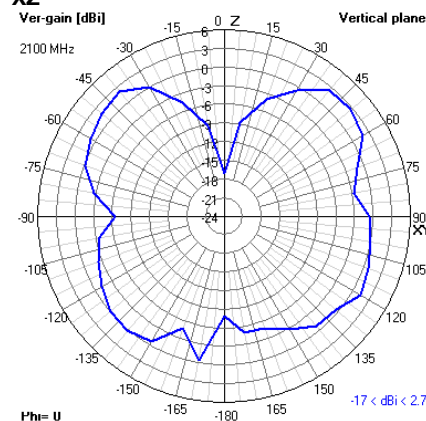

YZ

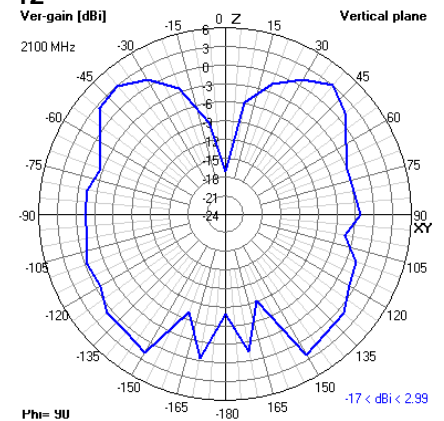



IP68 Oscar 40 Pro

5G/LTE Wideband IP68 Outdoor Antenna for 600-8000 MHz

2D Radiation Plots

2300 MHz XY

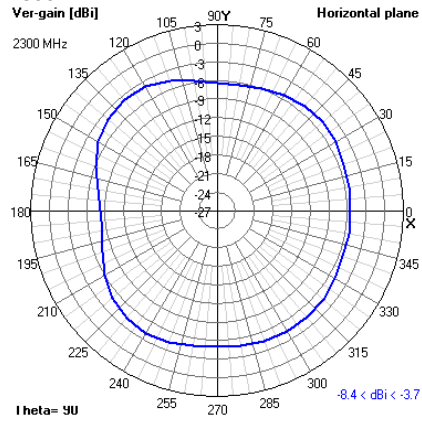

XZ

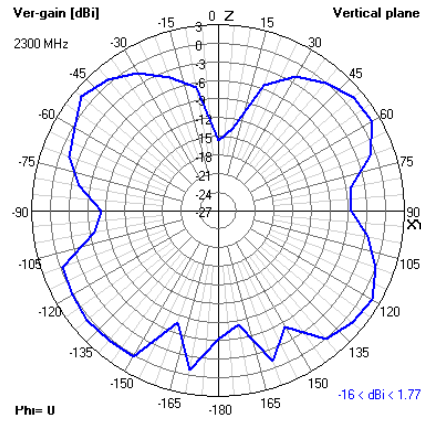

YZ

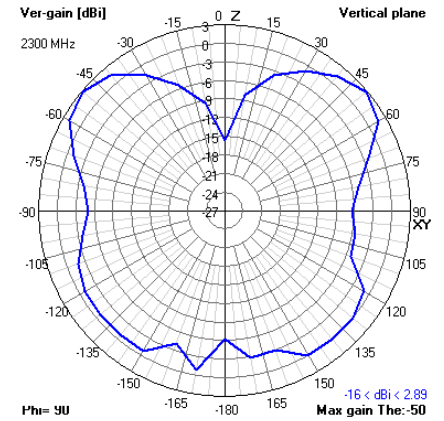

2400 MHz XY

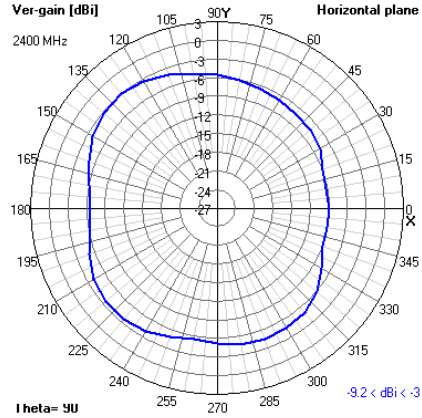

XZ

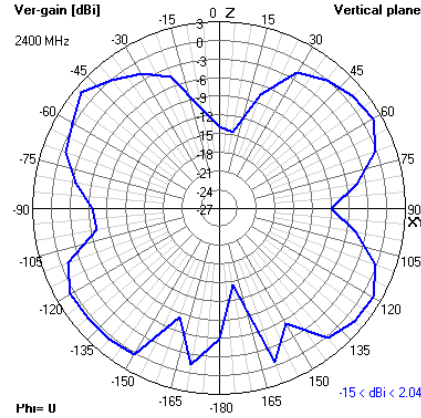

YZ

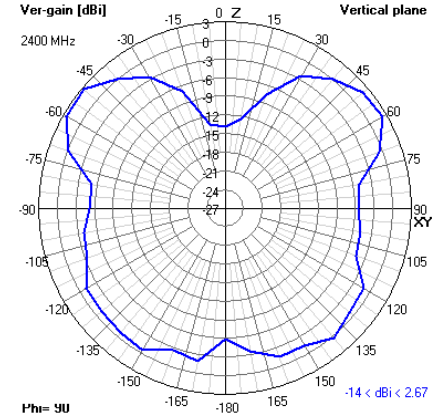

2500 MHz XY

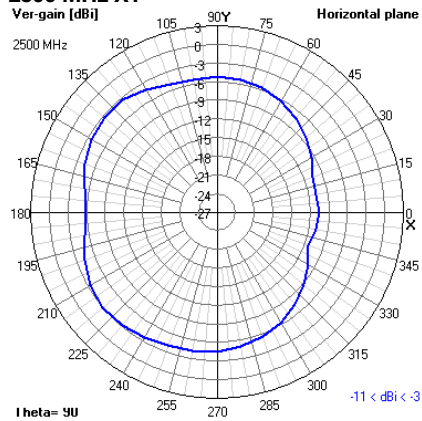

XZ

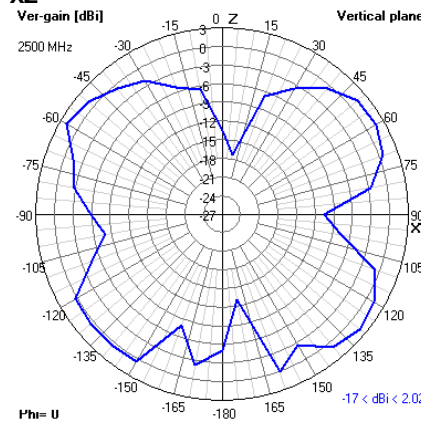

YZ

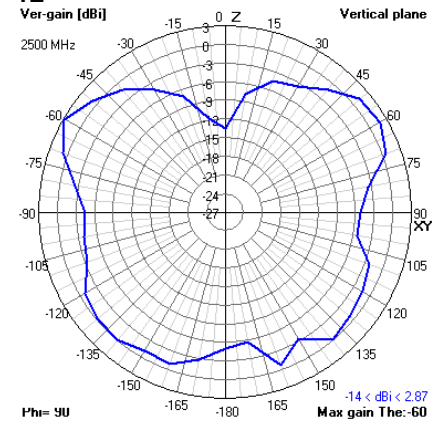



IP68 Oscar 40 Pro

5G/LTE Wideband IP68 Outdoor Antenna for 600-8000 MHz

2D Radiation Plots

2600 MHz XY

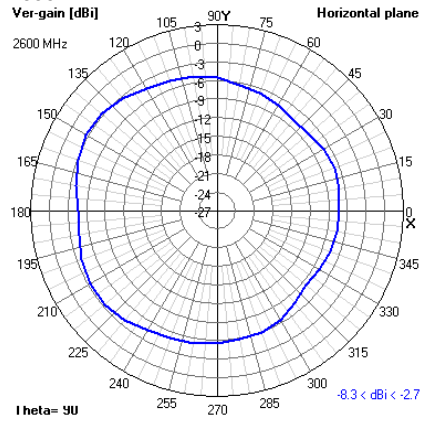

XZ

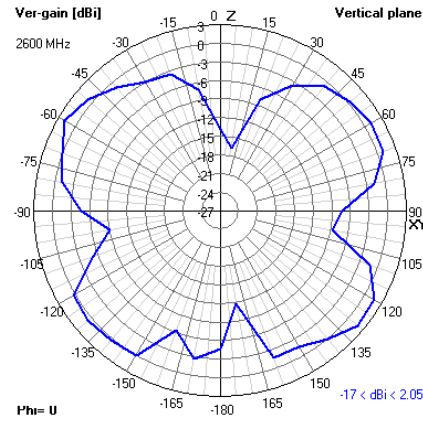

YZ

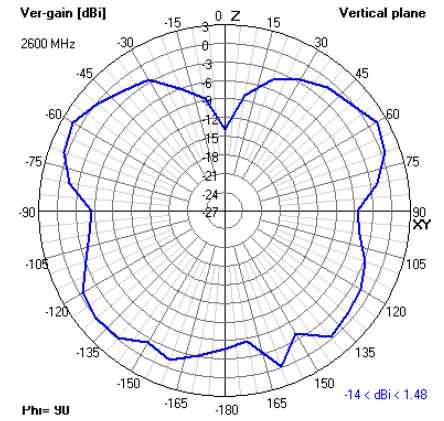

3300 MHz XY

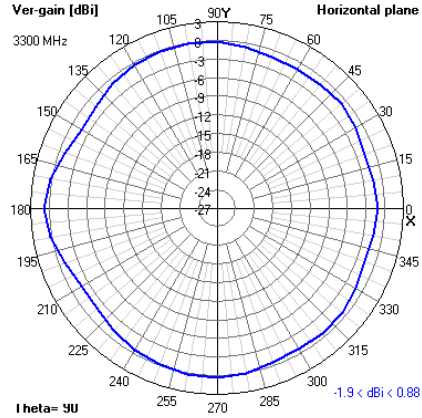

XZ

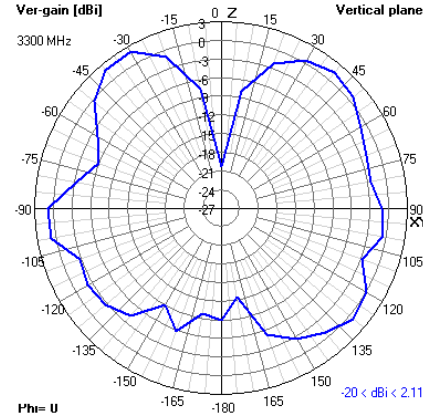

YZ

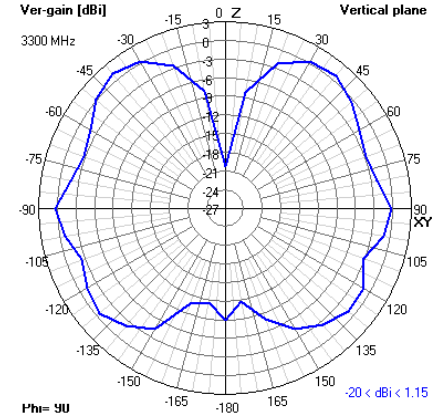

3500 MHz XY

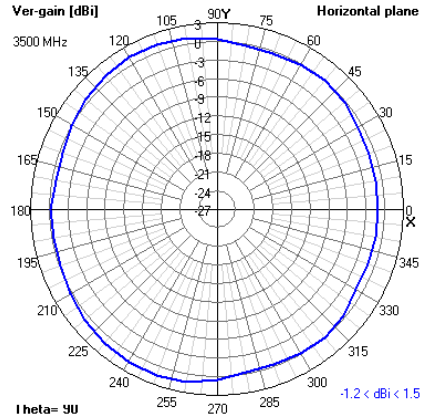

XZ

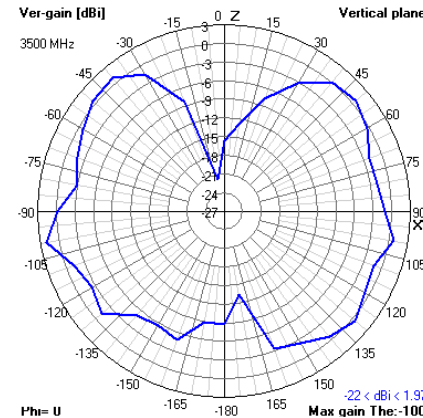

YZ

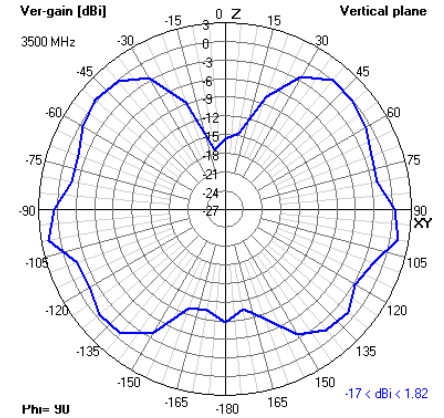



IP68 Oscar 40 Pro

5G/LTE Wideband IP68 Outdoor Antenna for 600-8000 MHz

2D Radiation Plots

3700 MHz XY

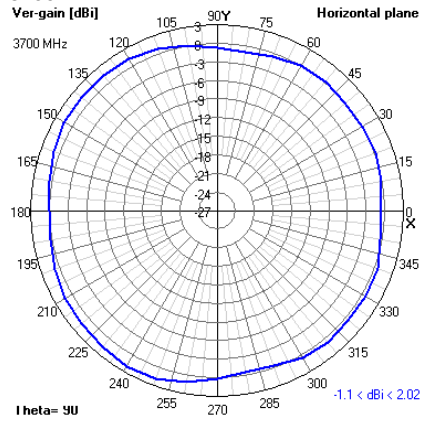

XZ

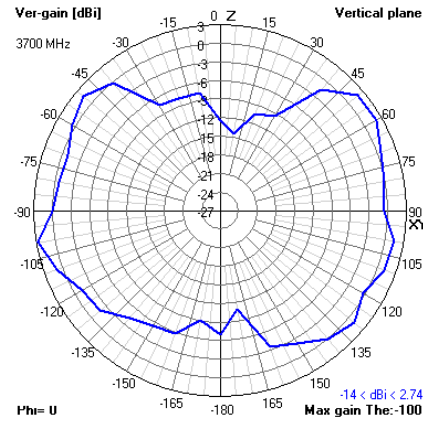

YZ

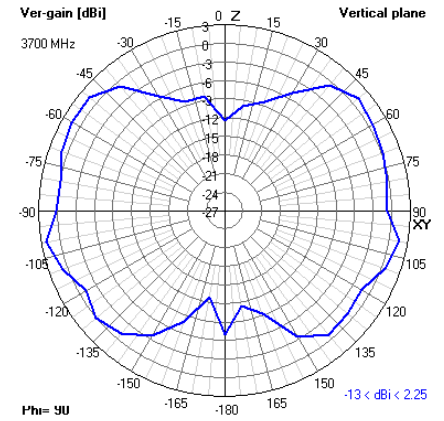

4700 MHz XY

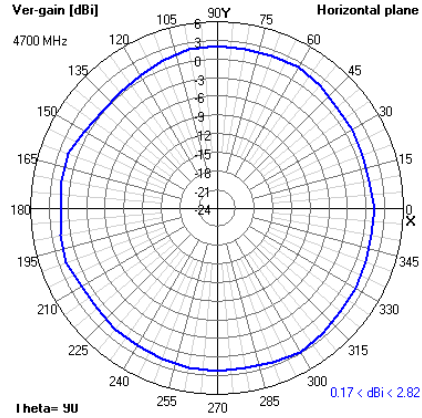

XZ

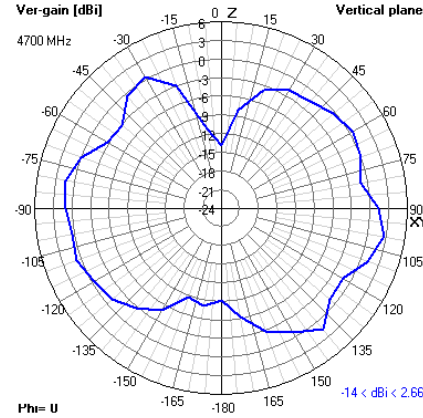

YZ

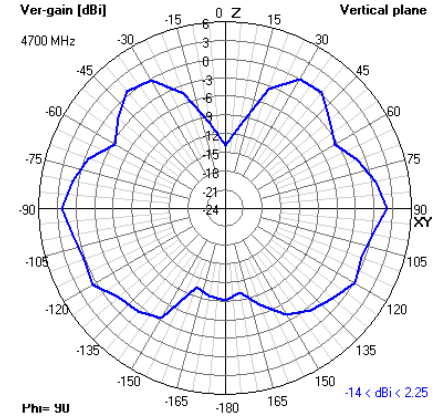

5200 MHz XY

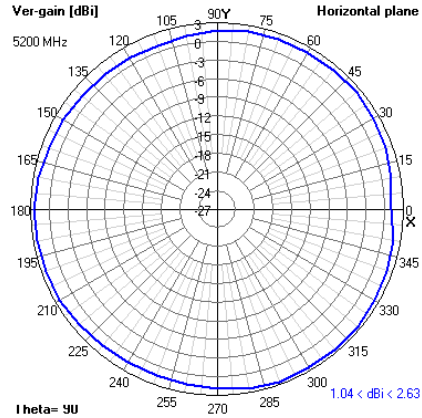

XZ

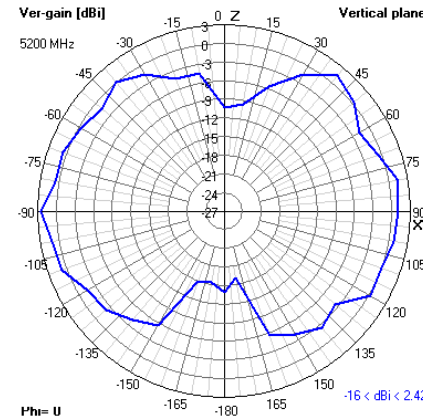

YZ

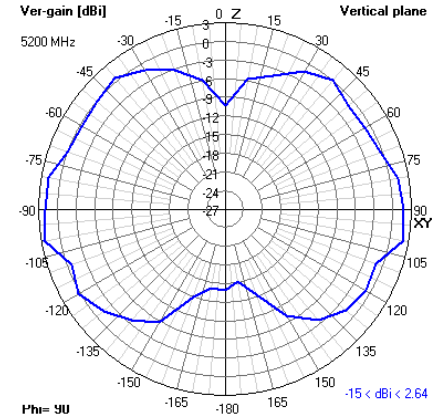



IP68 Oscar 40 Pro

5G/LTE Wideband IP68 Outdoor Antenna for 600-8000 MHz

2D Radiation Plots

5900 MHz XY

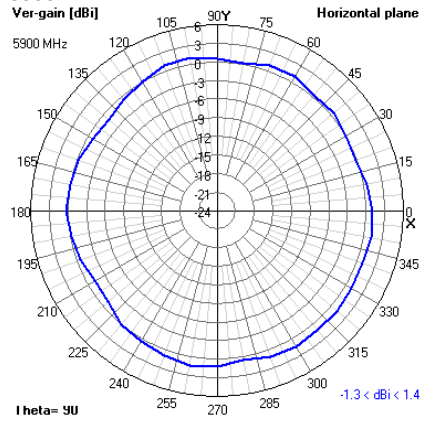

XZ

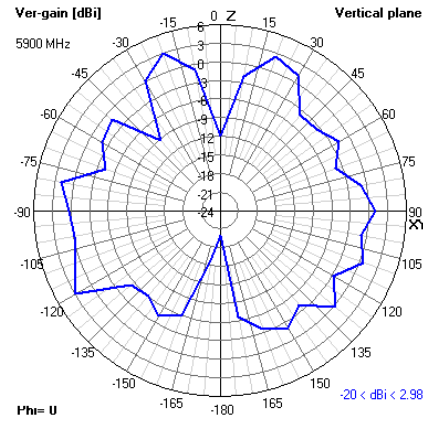

YZ

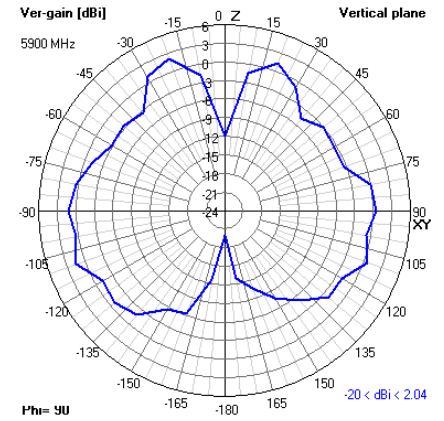

6000 MHz XY

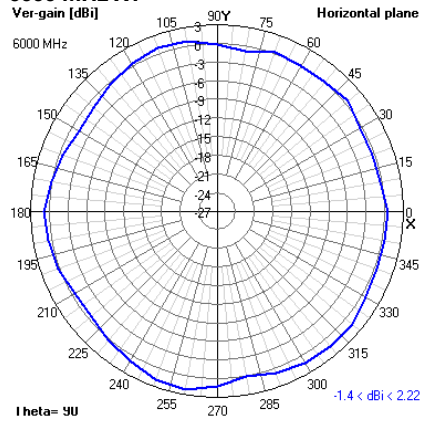

XZ

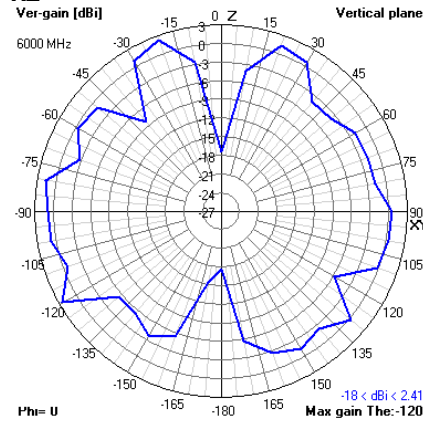

YZ

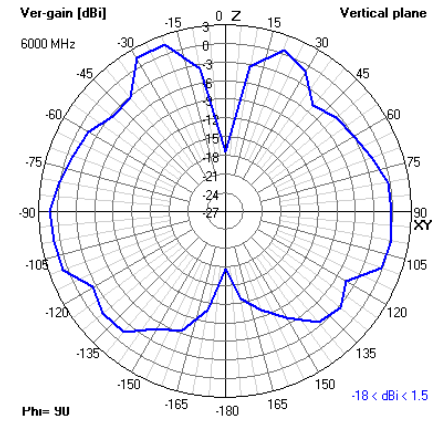

6060 MHz XY

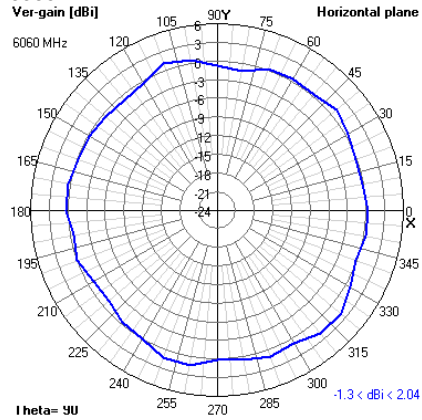

XZ

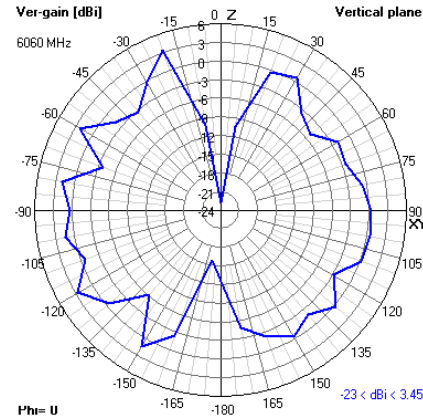

YZ

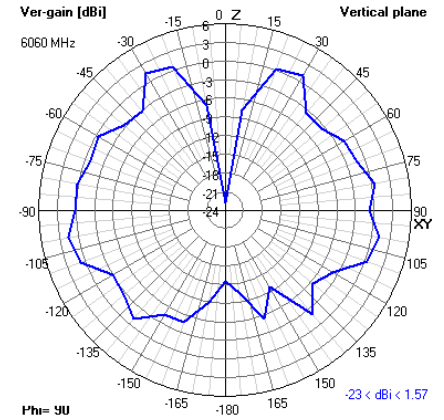



IP68 Oscar 40 Pro

5G/LTE Wideband IP68 Outdoor Antenna for 600-8000 MHz

2D Radiation Plots

6180 MHz XY

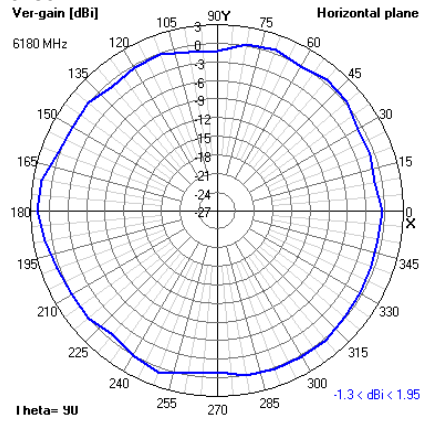

XZ

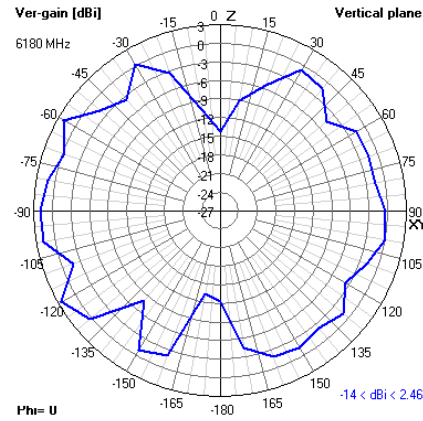

YZ

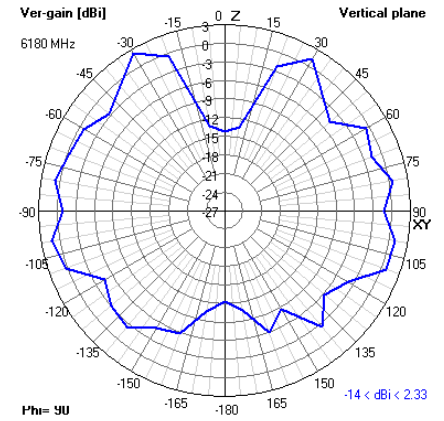

6200 MHz XY

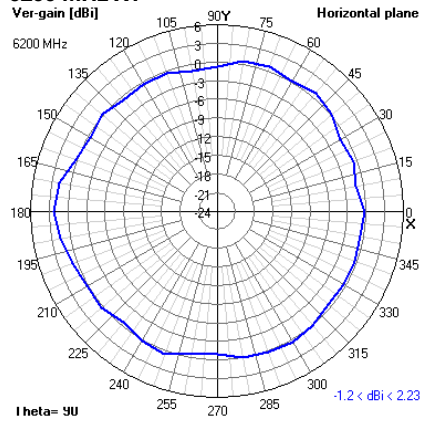

XZ

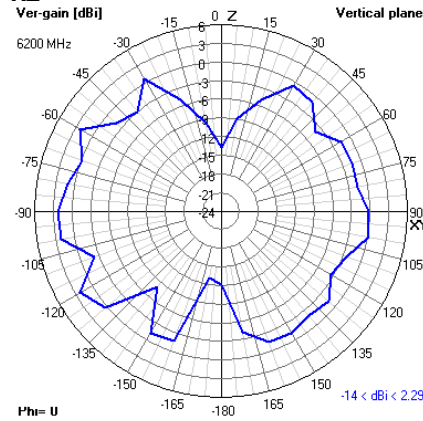

YZ

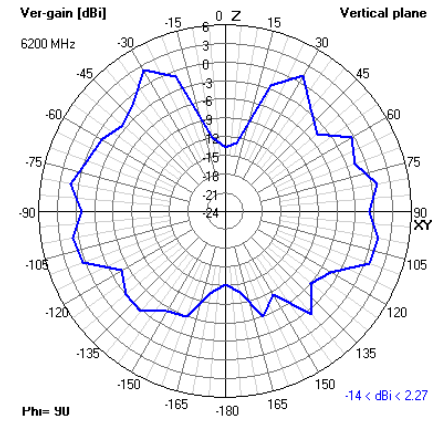

6520 MHz XY

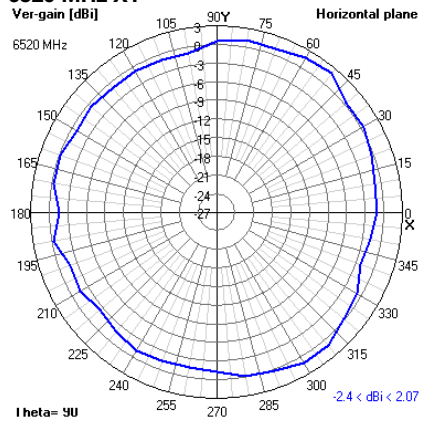

XZ

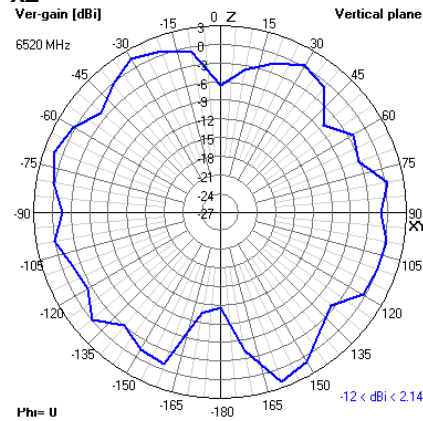

YZ

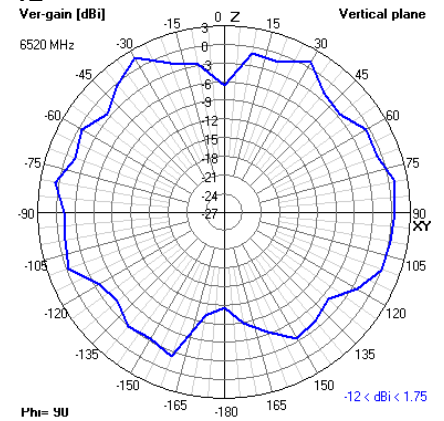



IP68 Oscar 40 Pro

5G/LTE Wideband IP68 Outdoor Antenna for 600-8000 MHz

2D Radiation Plots

6600 MHz XY

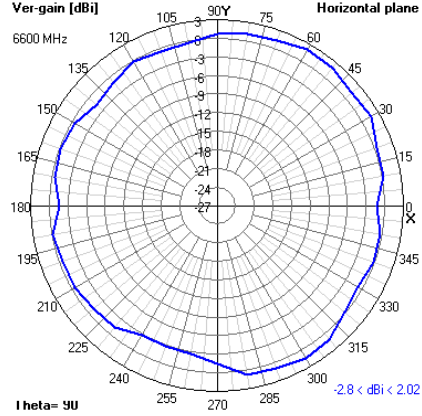

XZ

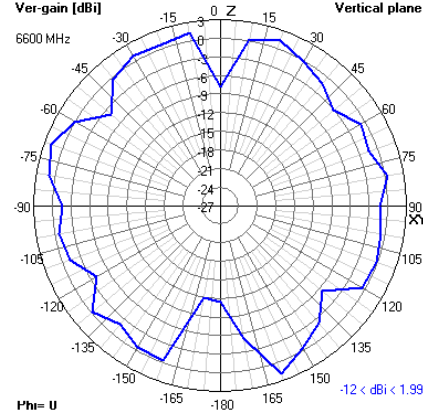

YZ

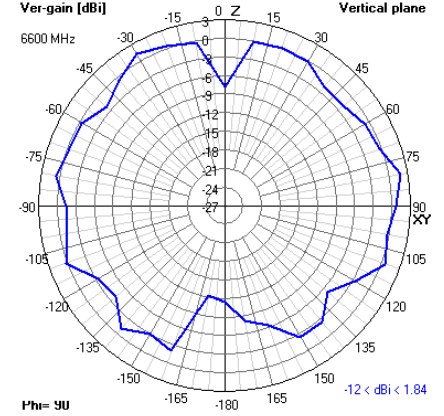

6700 MHz XY

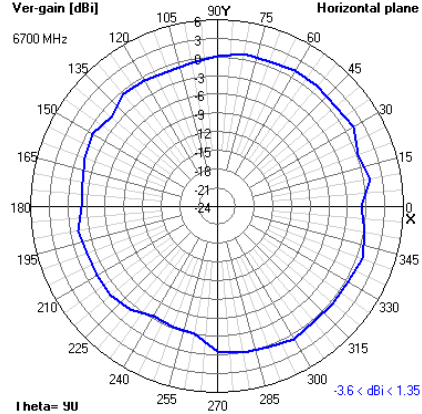

XZ

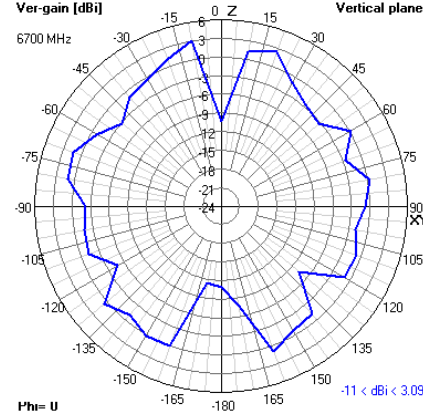

YZ

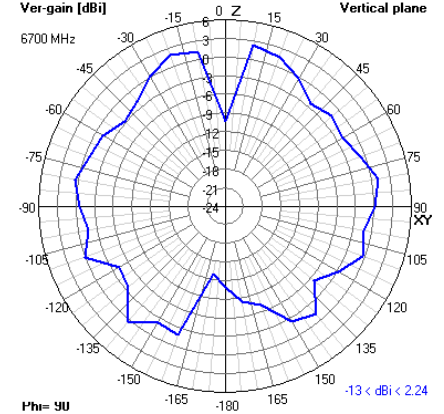



IP68 Oscar 40 Pro

5G/LTE Wideband IP68 Outdoor Antenna for 600-8000 MHz

3D Radiation Plots

600 MHz

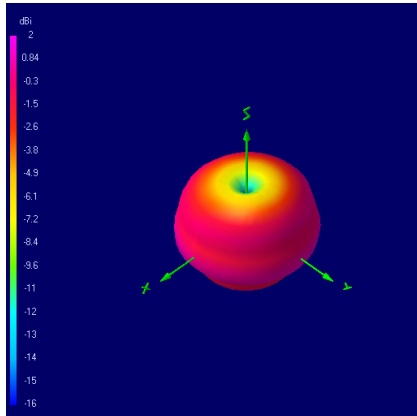

700 MHz

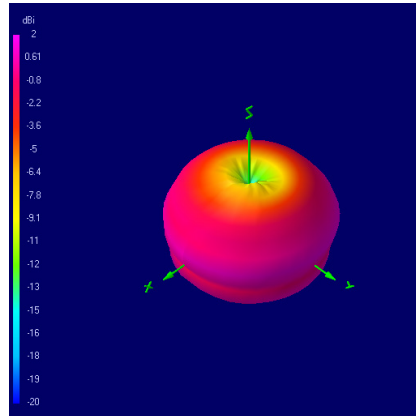

800 MHz

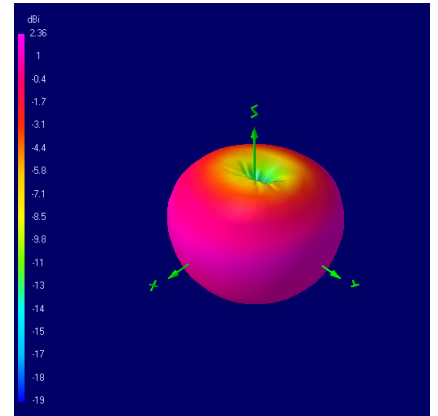

860 MHz

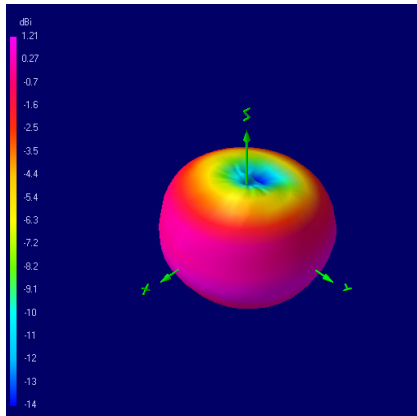

900 MHz

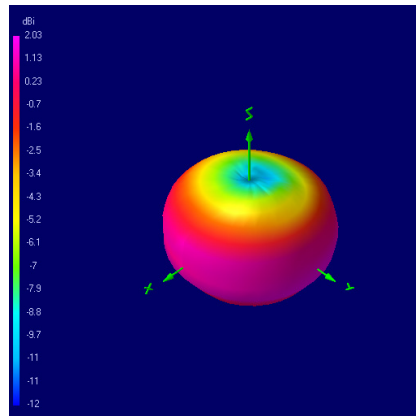

1500 MHz

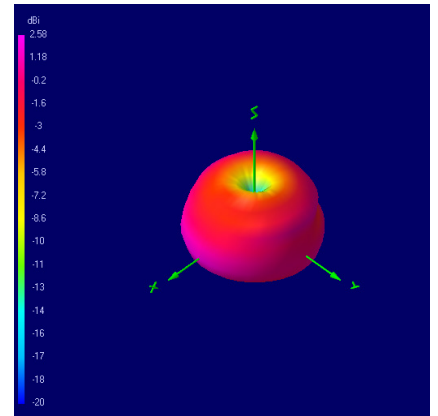

1600 MHz

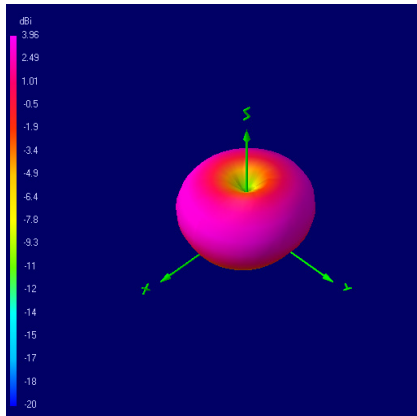

1700 MHz

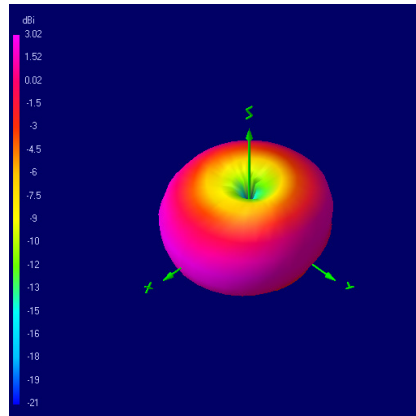

1800 MHz

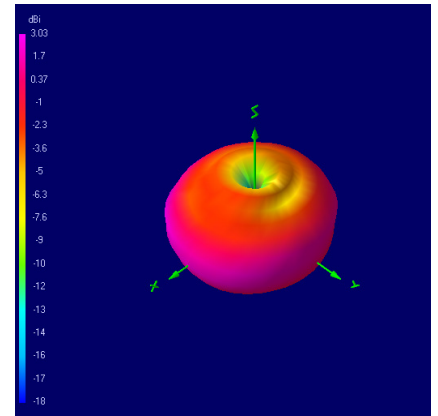



IP68 Oscar 40 Pro

5G/LTE Wideband IP68 Outdoor Antenna for 600-8000 MHz

3D Radiation Plots

1900 MHz

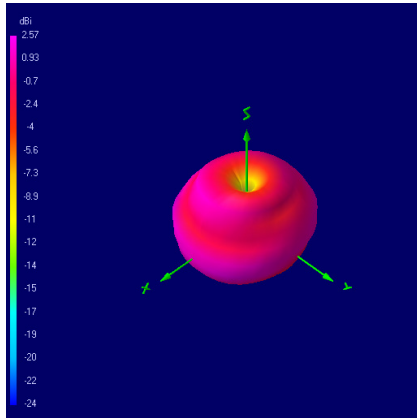

2000 MHz

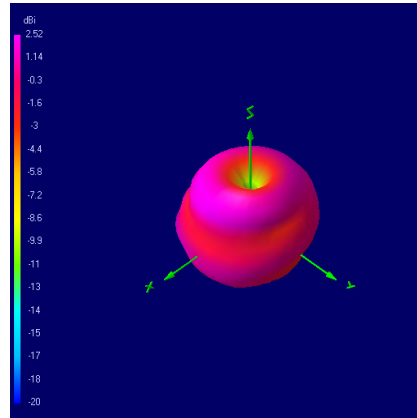

2100 MHz

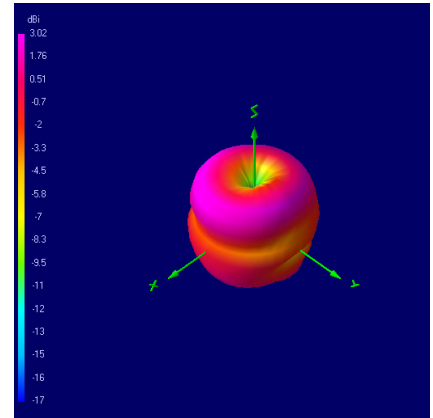

2300 MHz

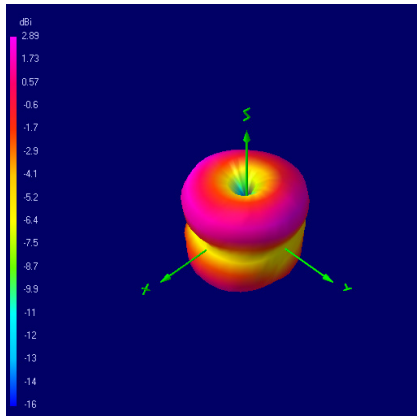

2400 MHz

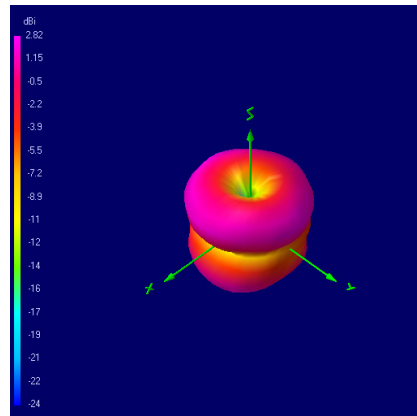

2500 MHz

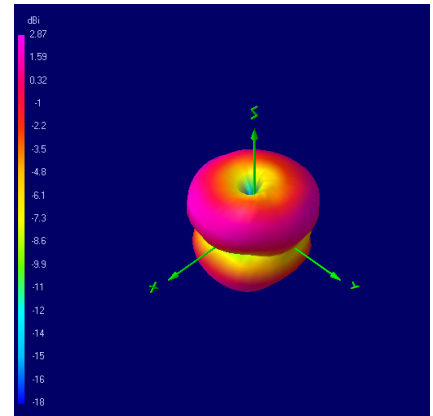

2600 MHz

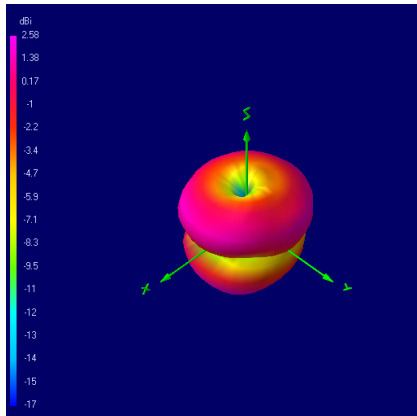

3300 MHz

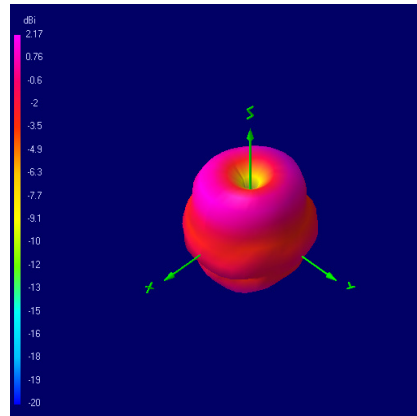

3500 MHz

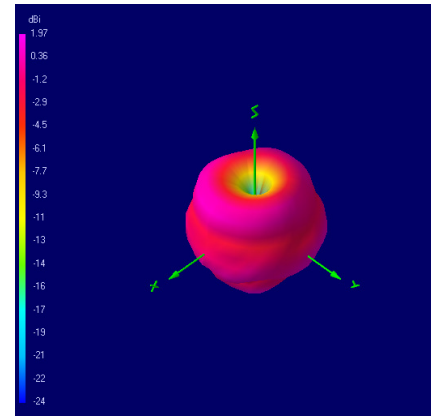



IP68 Oscar 40 Pro

5G/LTE Wideband IP68 Outdoor Antenna for 600-8000 MHz

3D Radiation Plots

3700 MHz

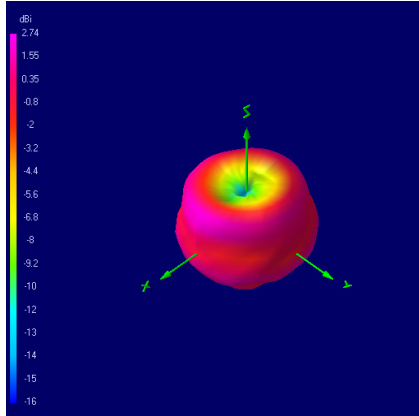

4700 MHz

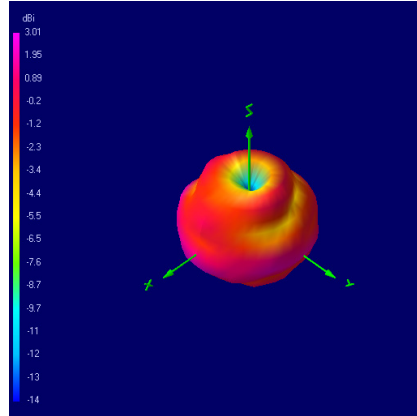

5200 MHz

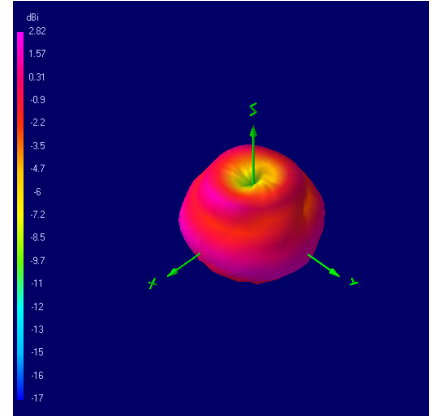

5900 MHz

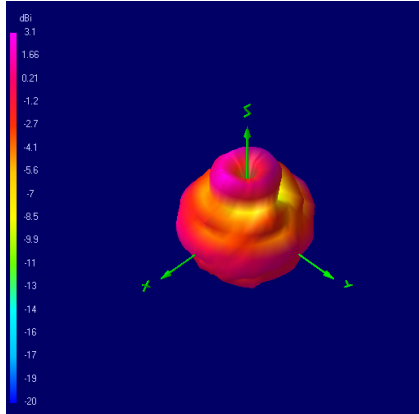

6000 MHz

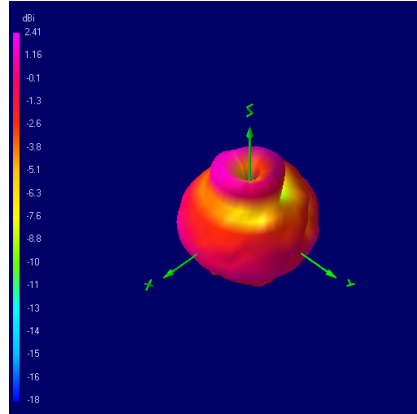

6060 MHz

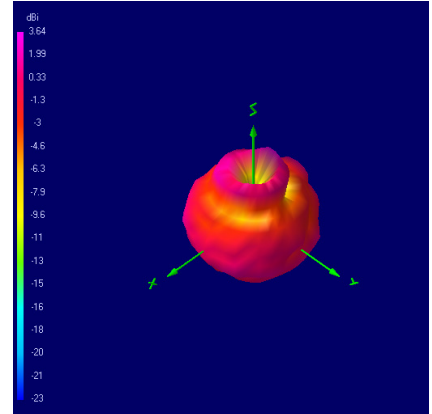

6180 MHz

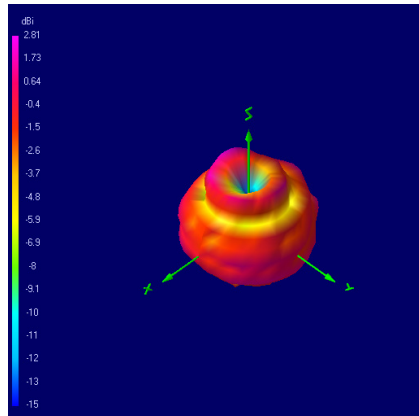

6200 MHz

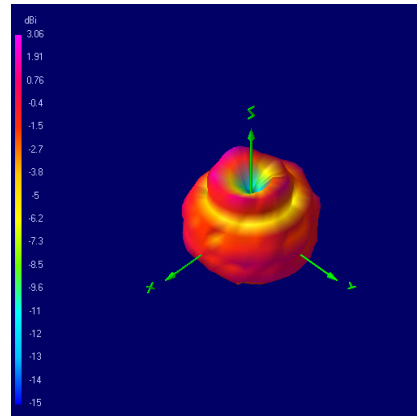

6520 MHz

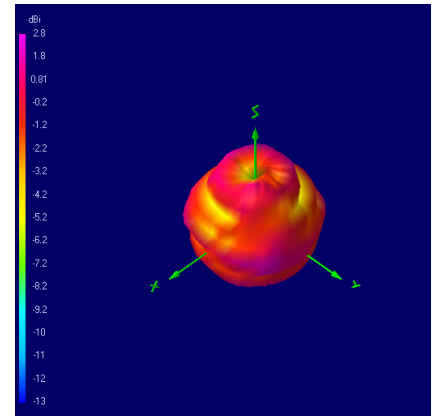



IP68 Oscar 40 Pro

5G/LTE Wideband IP68 Outdoor Antenna for 600-8000 MHz

3D Radiation Plots

6600 MHz

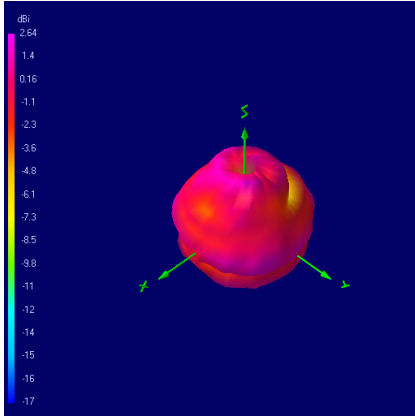

6700 MHz

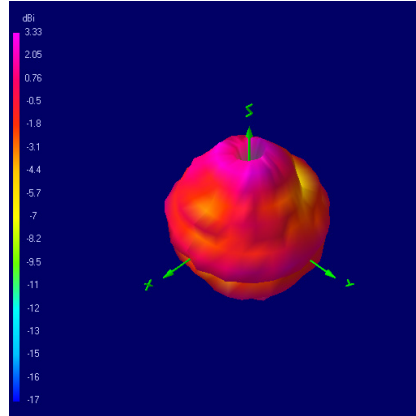

Ordering Details:

Part Number	Description
OSCAR40-PRO/10M/SMAM/S/LL/33/CL/W	5G/LTE WIDEBAND IP68 OUTDOOR ANTENNA 600-8000 MHZ 10M LOW LOSS CABLE AND SMA MALE CONNECTOR (WHITE RADOME)